

50
ANOS



pradolux

CATÁLOGO DE PRODUTOS 2026

uma empresa



Tornar caminhos mais seguros e iluminados

Na Pradolux, esse propósito orienta tudo o que fazemos. Ele expressa nosso compromisso em conectar tecnologia, engenharia e inovação para promover segurança, confiabilidade e clareza em cada solução de iluminação automotiva, impactando positivamente pessoas, negócios e a mobilidade.

Motivação e Propósito

Segurança em Cada Quilômetro

Cada produto que criamos carrega o compromisso de garantir segurança nos caminhos. Mais do que luz, entregamos confiança, iluminando jornadas e contribuindo para um transporte mais seguro.

Portfólio Completo

Soluções para Cada Caminhão nas Estradas

Com 50 anos de experiência e um dos maiores portfólios de iluminação para veículos pesados, a Pradolux tornou-se sinônimo de FULL SUPPLY. Nossos produtos atendem às diferentes necessidades de iluminação automotiva, contribuindo para a segurança nas estradas.

Inovação e Engenharia

Tecnologia que Garante Qualidade

Na Pradolux, cada produto reflete pesquisa, engenharia e inovação. Com desenvolvimento constante e foco em desempenho e confiabilidade, oferecemos soluções que consolidam nossa posição no mercado de reposição automotiva.

Pessoas e Excelência

Times comprometidos com o Aperfeiçoamento

Nada disso seria possível sem nossos times dedicados. Em cada projeto, nossos profissionais buscam evoluir continuamente, garantindo inovação, qualidade e confiabilidade para nossos clientes e parceiros.

Certificações e Qualidade

Padrões Reconhecidos Internacionalmente

A Pradolux opera sob rigorosos padrões de gestão e qualidade. A empresa possui certificações ISO 9001, IATF 16949, ISO 14001:2015 e ISO/IEC 17025, reforçando seu compromisso com a melhoria contínua, a satisfação dos clientes e a gestão ambiental responsável.

Soluções para OEM

Engenharia para Novos Desafios da Iluminação

A experiência e o know-how da Pradolux também permitem atender projetos do mercado OEM, desenvolvendo soluções com tecnologias avançadas para atender às exigências técnicas e regulatórias das montadoras.

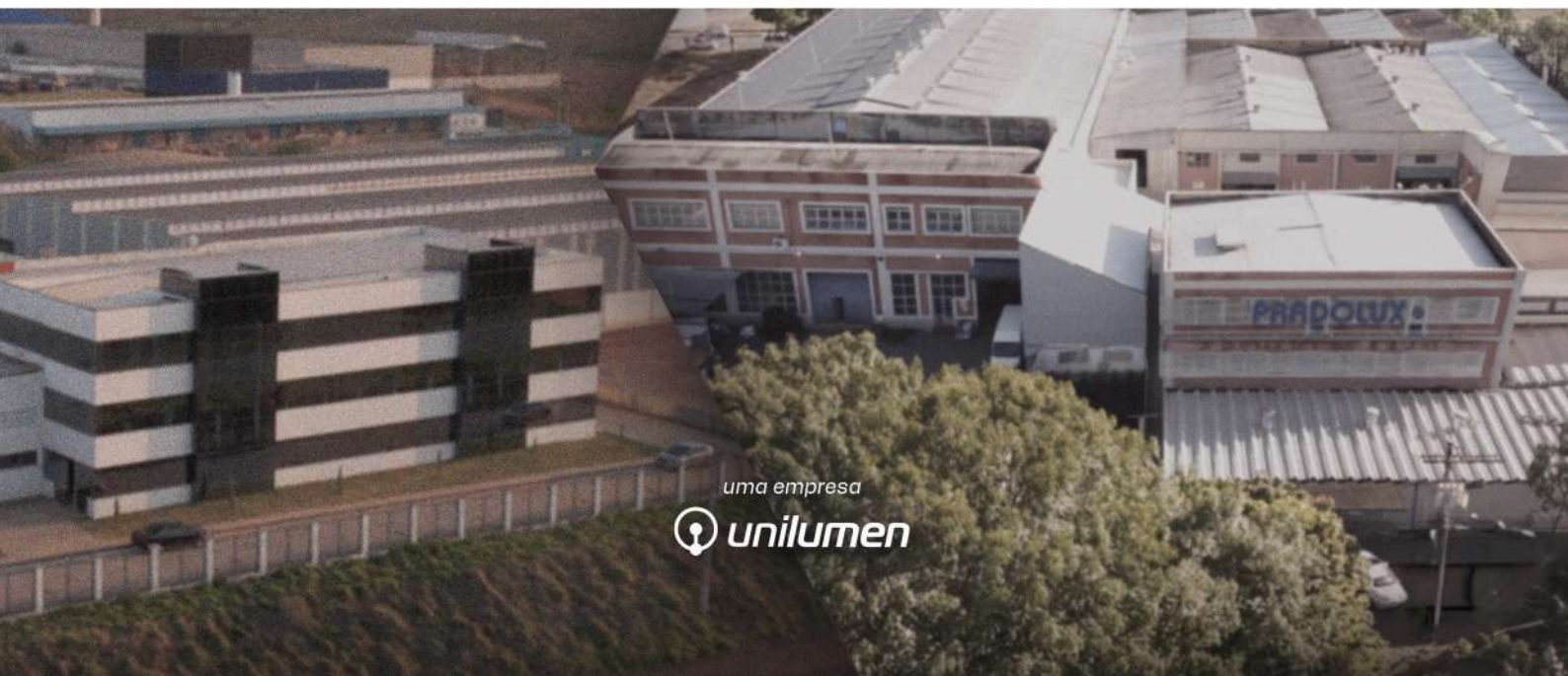

IMPLEMENTOS 07

CAMINHÕES 28

ÔNIBUS 81

UTILITÁRIOS 84

ACESSÓRIOS 87

SOQUETES 90

CÓDIGO DA SÉRIE	PÁG.	CÓDIGO DA SÉRIE	PÁG.	CÓDIGO DA SÉRIE	PÁG.	CÓDIGO DA SÉRIE	PÁG.	CÓDIGO DA SÉRIE	PÁG.	CÓDIGO DA SÉRIE	PÁG.		
PL0200	18	PL0524	22	PL0692	35	PL0886	08	PL2038	16	PL6114	59	PL9916	90
PL0202	18	PL0526	21 - 22 - 82	PL0694	35	PL0890	70	PL2040	16	PL6118	59	PL9917	90
PL0204	18	PL0528	51	PL0696	71	PL0896	69	PL2048	16	PL7000	66	PL9918	90
PL0206	25	PL0530	70	PL0698	71	PL0898	70	PL2050	16	PL7002	46	PL9919	90
PL0270	32 - 70	PL0532	53	PL0700	77	PL0902	26	PL2058	15	PL7004	46	PL9920	90
PL0306	35	PL0534	69	PL0702	80	PL0904	26	PL2066	15	PL7006	30	PL9921	90
PL0310	27	PL0536	20	PL0704	78 - 81	PL0912	55	PL2070	15	PL7008	30	PL9922	91
PL0312	22	PL0538	23	PL0706	79	PL0914	55	PL2076	15	PL7010	29	PL9923	91
PL0348	49	PL0540	61	PL0708	77	PL0916	55	PL2102	13	PL7012	29	PL9924	91
PL0400	85	PL0542	87	PL0710	79	PL0986	68	PL2104	13	PL7014	30	PL9925	91
PL0402	84	PL0544	27	PL0714	78	PL0988	68	PL2220	07	PL7016	30	PL9926	91
PL0404	89	PL0547	70	PL0716	33 - 54	PL0994	13	PL2300	14	PL7018	65	PL9928	91
PL0406	31	PL0548	51	PL0720	40	PL0996	70	PL2304	14	PL7020	65	PL9929	91
PL0408	49	PL0554	71 - 82	PL0722	39	PL1000	86	PL2600	12	PL7022	68	PL9930	91
PL0410	49 - 86	PL0564	22	PL0728	80	PL1002	86	PL2606	12	PL7026	48	PL9931	91
PL0412	22	PL0566	22	PL0730	40	PL1004	86	PL2700	09	PL7028	46	PL9932	91
PL0420	35	PL0572	69 - 82	PL0731	13	PL1006	85	PL2702	09	PL7030	48	PL9933	91
PL0422	84	PL0574	52	PL0732	39	PL1008	85	PL2704	11	PL7036	66	PL9934	91
PL0424	84	PL0576	52	PL0734	39	PL1012	85	PL6004	77	PL7038	66	PL9935	91
PL0426	32 - 53	PL0578	21	PL0736	40	PL1020	85	PL6006	45	PL7040	67	PL9936	91
PL0428	53	PL0580	53	PL0738	39	PL1022	85	PL6008	76	PL7042	67	PL9945	91
PL0434	31	PL0582	21 - 83	PL0740	78	PL1308	81	PL6010	76	PL7044	67	PL9946	91
PL0438	61	PL0584	21	PL0742	40	PL1310	81	PL6016	59	PL7046	84	PL9947	92
PL0440	32 - 72 - 86	PL0586	20	PL0744	78	PL1314	30 - 81	PL6018	75	PL7050	48	PL9948	92
PL0442	70	PL0588	52	PL0746	79	PL1322	27	PL6020	76	PL7052	49	PL9950	92
PL0446	60	PL0590	23	PL0748	40	PL1334	27	PL6022	75	PL7054	48 - 68	PL9951	92
PL0448	50	PL0592	52	PL0750	60	PL1340	82	PL6024	38	PL7056	48	PL9952	92
PL0450	50 - 81	PL0594	51	PL0752	79	PL1354	21 - 83	PL6026	67	PL7058	49	PL9953	92
PL0452	89	PL0598	69	PL0754	39	PL1427	53 - 82	PL6028	58	PL7060	47	PL9954	92
PL0458	87	PL0600	88	PL0756	20 - 83	PL1442	62	PL6030	45	PL7062	47	PL9955	92
PL0460	31	PL0602	88	PL0758	20 - 83	PL1446	59	PL6032	45	PL7064	30	PL9956	92
PL0462	32	PL0606	26	PL0760	19 - 82	PL1452	10	PL6035	77	PL9101	94	PL9958	92
PL0464	31	PL0608	26	PL0762	19 - 82	PL1454	61	PL6036	45	PL9102	94	PL9960	16
PL0466	49	PL0612	52	PL0764	59	PL1456	61	PL6038	46	PL9103	94	PL9964	17
PL0470	32 - 70	PL0614	61	PL0766	79	PL1500	07	PL6040	67	PL9104	94	PL9966	17
PL0474	31	PL0624	49	PL0768	79	PL1527	39 - 83	PL6042	57	PL9105	94	PL9968	17
PL0476	49	PL0632	35	PL0770	79	PL1544	59	PL6044	77	PL9106	94	PL9974	92
PL0478	59	PL0638	23	PL0772	60	PL1550	80	PL6046	34	PL9107	94	PL9975	92
PL0480	27	PL0640	24	PL0780	20	PL1560	12	PL6048	34	PL9108	94	PL9976	92
PL0482	71	PL0642	24	PL0782	19	PL1580	40	PL6050	68	PL9109	94	PL9977	92
PL0484	60	PL0646	23	PL0788	20	PL1582	80	PL6052	34	PL9110	94	PL9978	92
PL0486	79	PL0648	40	PL0790	13	PL1614	61	PL6054	34	PL9200	94	PL9981	92
PL0488	84	PL0650	88	PL0796	19	PL1616	62	PL6056	45	PL9201	94	PL9983	93
PL0492	51	PL0656	24	PL0798	19	PL1618	72	PL6058	76	PL9202	94	PL9984	93
PL0494	31	PL0660	24	PL0800	19	PL1620	35	PL6060	58	PL9203	94	PL9985	93
PL0496	31	PL0662	68	PL0802	87	PL1622	71	PL6062	58	PL9204	94	PL9986	93
PL0498	50	PL0664	70	PL0804	87	PL1624	60	PL6064	58	PL9205	94	PL9987	93
PL0500	53	PL0670	25	PL0806	19	PL1700	77	PL6066	76	PL9900	90	PL9988	93
PL0502	87	PL0672	25	PL0810	87	PL1702	80	PL6068	76	PL9901	90	PL9989	93
PL0506	87	PL0674	25	PL0820	19	PL1704	78	PL6070	46	PL9903	90	PL9990	93
PL0510	51 - 60	PL0676	25	PL0826	36	PL1708	77	PL6072	45	PL9906	90	PL9991	93
PL0512	89	PL0678	21	PL0828	36	PL1710	78	PL6074	57	PL9907	90	PL9994	93
PL0514	52	PL0680	84	PL0830	36	PL1800	07	PL6076	57	PL9909	90	PL9995	93
PL0516	53 - 86	PL0682	35	PL0860	39	PL2000	15	PL6078	58	PL9911	90	PL9996	93
PL0518	51	PL0684	21	PL0862	78	PL2004	17	PL6080	76	PL9913	90	PL9997	93
PL0520	51	PL0688	23	PL0864	49	PL2008	17	PL6082	77	PL9914	90	PL9998	93
PL0523	83	PL0690	23	PL0870	50	PL2010	14	PL6112	59	PL9915	90	PL9999	93

pradolux

1976-1985

A Pradolux nasceu em 1976, quando Luiz Prado identificou a crescente demanda por soluções em iluminação e sinalização veicular no Brasil. Com foco em qualidade e inovação para o transporte brasileiro, a empresa rapidamente se consolidou e, ainda na década de 1980, iniciou suas exportações, levando a indústria nacional ao mercado internacional.



2005

Em 2005, com a duplicação da fábrica para uma área de aproximadamente 8.000 m², a Pradolux fortaleceu sua capacidade produtiva e intensificou investimentos em novas tecnologias, gestão e desenvolvimento de produtos, elevando de forma consistente o padrão técnico e a qualidade de suas soluções.

2006

A consolidação da Pradolux no cenário internacional ocorreu em 2006, com sua participação na Automechanika Frankfurt, por meio do programa "Brasil Excellence in Autoparts". A partir desse marco, a marca passou a ser reconhecida internacionalmente como sinônimo de tecnologia, qualidade e confiabilidade da indústria brasileira.



2007-2009

Nesse período, a Pradolux passou a utilizar tecnologias CAD/CAM/CAE, ampliando sua capacidade de projetar e desenvolver produtos com mais precisão e confiabilidade. Em 2009, reforçou seu compromisso com a qualidade ao conquistar a certificação ISO 9001, consolidando práticas de padronização e melhoria contínua.

Há 50 anos tornando caminhos mais seguros e iluminados

2018

Em 2018, a Pradolux inaugurou sua nova planta industrial em Poços de Caldas (MG), com área aproximada de 30 mil m². Moderna e sustentável, a nova estrutura marcou também o nascimento da Luxparts, unidade produtiva dedicada à automação industrial e à fabricação de componentes avançados, ampliando as capacidades tecnológicas e produtivas do grupo.



PRADOLUX®

2023-2024

A acreditação do Laboratório de Fotometria pela ISO 17025, concedida pelo INMETRO, marcou um avanço estratégico para a Pradolux, garantindo medições acreditadas e maior confiabilidade técnica. Em 2024, a empresa alcançou novos marcos com a certificação IATF e o início da produção nacional de faróis com resinas de engenharia, consolidando sua evolução como referência em iluminação automotiva.



2019

Neste ano, nasceu a Innova Lite, marca do grupo voltada à inovação em produtos LED e tecnologias emergentes.

Estruturada sob um modelo de startup, foi criada para acelerar o desenvolvimento de soluções e a presença da marca no mercado, registrando crescimento de vendas consistente desde seu lançamento.

50 ANOS

pradolux
50 anos

2026

Ao celebrar cinco décadas de história, a Pradolux reafirma sua trajetória de inovação e expansão, iluminando estradas no Brasil e no mundo e mantendo vivo seu propósito de tornar caminhos mais seguros e iluminados.

A Pradolux está comprometida com a responsabilidade social e acredita que o desenvolvimento sustentável depende de atitudes voltadas à preservação do meio ambiente e ao bem-estar.

Promovemos iniciativas ambientais e sociais por meio da destinação de resíduos de garantia, defeitos e quebras para reciclagem. A coleta é realizada por representantes comerciais e os materiais são encaminhados às cooperativas, que os recebem como doação.



O projeto **Sempre Verde** incentiva ações de reflorestamento e conscientização ambiental. A iniciativa já resultou no plantio de **35 árvores frutíferas na Luxparts** e de **150 árvores nativas em uma área de 1.200 m²**, cedida pela prefeitura, envolvendo colaboradores e clientes em uma ação coletiva de preservação.



Em 2024, com o apoio da equipe comercial, a empresa ampliou essas iniciativas, fortalecendo a destinação correta de resíduos e promovendo a arrecadação de recursos destinados a instituições beneficentes locais.

*Participe você também!
Faça parte de um futuro mais verde.*



Leve a tecnologia da Pradolux para dentro do seu negócio

Apresente nossos produtos em 3D



Acesse o APP
e confira todas as novidades





Com maior visibilidade, LED Bivolt.
Com funções de posição, luz de ré, freio e direcional sequencial

Com conector 5 vias e 3 conectores auxiliares 2 vias

Com lente em acrílico

Primeira e única lanterna modular do mercado!



PL 1500

Lanterna traseira Modulus®
Com 60 LEDs bivolt.

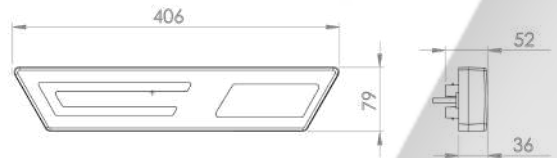

CÓDIGO	SEM LCM	
	LADO	EMB.
PL1500.01.67	Direito	01
PL1500.02.67	Esquerdo	01

CÓDIGO	COM LCM*	
	LADO	EMB.
PL1500.21.67	Direito	01
PL1500.22.67	Esquerdo	01

*LCM: Módulo controlador das luzes direcionais das lanternas laterais.

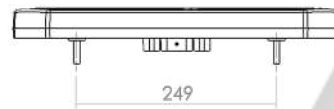

PL 1800

Lanterna traseira Modulus®
com triângulo e 78 LEDs bivolt



CÓDIGO	SEM LCM	
	LADO	EMB.
PL1800.01.67	Direito	01
PL1800.02.67	Esquerdo	01

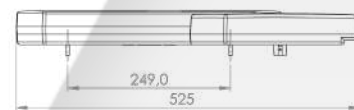
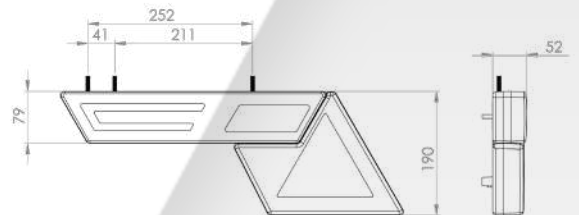

PL 2220

Lanterna traseira Modulus®
com ponteira de acabamento e 78 LEDs bivolt



CÓDIGO	SEM LCM	
	LADO	EMB.
PL2220.01.67	Direito	01
PL2220.02.67	Esquerdo	01

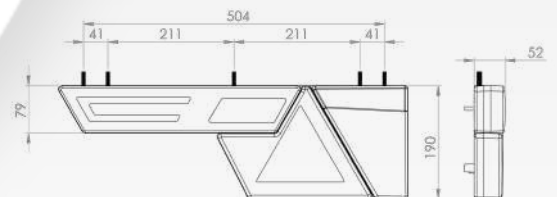

REPOSIÇÃO

Triângulo retrorrefletor LED
Com lente em acrílico



Ponteira de acabamento
Com lente em acrílico



CÓDIGO	SEM LCM	
	LADO	EMB.
PL1802.01.63	Direito	01
PL1802.02.63	Esquerdo	01

CÓDIGO	SEM LCM	
	LADO	EMB.
PL2220.01.23	Direito	01
PL2220.02.23	Esquerdo	01

Chicote universal
Com conector ultra seal 2 vias



CÓDIGO	EMB.
PL9946.17.00	10

Chicote universal
Com conector ultra seal 5 vias e Faston 6,3mm



CÓDIGO	EMB.
PL9953.39.00	10



- 1 - GND
- 2 - Freio
- 3 - Posição
- 4 - Direcional
- 5 - Luz de ré

PL 0886

Lanterna traseira Phantom LED
Com 46 LEDs RGB

Com conector 5 vias e
2 conectores auxiliares 2 vias

Com funções de
posição, luz de ré, freio
e direcional sequencial

Com lente em acrílico vermelha fumê

RGB
PHANTOM
LED



LED BIVOLT

IP67



CÓDIGO	LADO	EMB.
PL0886.01.64	Direito	01
PL0886.02.64	Esquerdo	01

Com lente em acrílico fumê



CÓDIGO	LADO	EMB.
PL0886.01.62	Direito	01
PL0886.02.62	Esquerdo	01

Lanterna completa com todas as funções

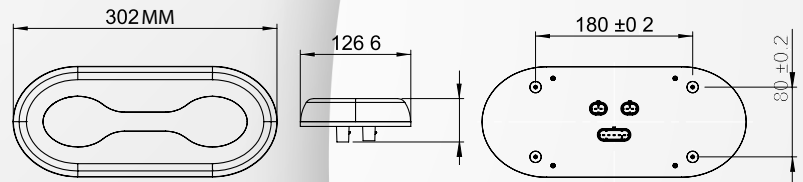

Lanterna traseira Phantom LED
Com 42 LEDs

Com conector 5 vias e
2 conectores auxiliares 2 vias

Com funções de
posição, luz de ré, freio
e direcional

Com lente em acrílico vermelha

Phantom
LED

IP67

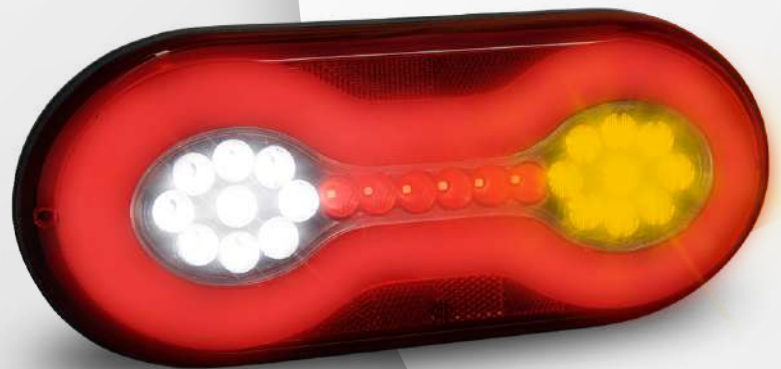

CÓDIGO	TENSÃO	LADO	EMB.
PL0886.11.67	LED 12V	Direito	01
PL0886.12.67	LED 12V	Esquerdo	01
PL0886.33.67	LED 24V	Direito	01
PL0886.34.67	LED 24V	Esquerdo	01

Mais opções de conexões no caminhão

vista traseira

Lado esquerdo

Conexão 2 vias para
alarme sonoro de ré
(uso opcional)

Lado direito

Conexão 2 vias para luz de Posição
ou luz de Placa (uso opcional)

Conexão 5 vias
para as funções Posição,
Seta, Ré e Freio

Conexão 2 vias para luz de Posição
ou luz de Placa (uso opcional)



PL 2700

Suporte traseiro Phantom LED
Com 42 LEDs

Phantom LED

Com conector 5 vias e
2 conectores auxiliares 2 vias

Com funções de posição,
direcional, luz de ré e freio

Com triângulo retrorrefletor
para reboques e semirreboques

Com lente em acrílico

LED24V

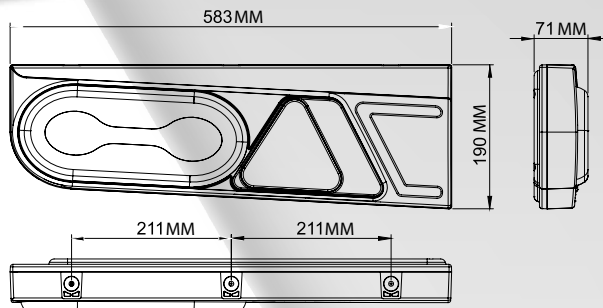
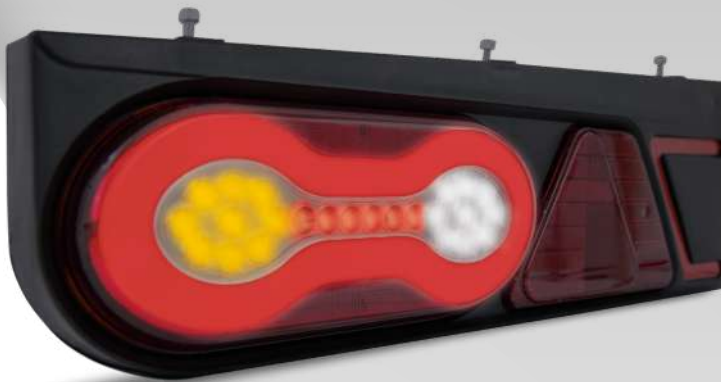

CÓDIGO	LADO	EMB.
PL2700.33.67	Direito	01
PL2700.34.67	Esquerdo	01



REPOSIÇÃO

Caixa com triângulo retrorrefletor
para suporte traseiro PL2700



CÓDIGO	LADO	EMB.
PL2700.65.17	Direito	01
PL2700.66.17	Esquerdo	01

Triângulo retrorrefletor
Com lente acrílica para suporte PL2700



CÓDIGO	LADO	EMB.
PL0994.01.23	Direito	04
PL0994.02.23	Esquerdo	04

Chicote universal
Com conector ultra seal 2 vias



CÓDIGO	EMB.
PL9946.17.00	10

Chicote universal
Com conector ultra seal 5 vias e Faston 6,3mm



CÓDIGO	EMB.
PL9953.39.00	10



PL 2702

Suporte traseiro Triplo X LED
Com triângulo retrorrefletor

Lanterna com lateral LED

Com conector 5 vias e
2 conectores auxiliares 2 vias

Com funções de
posição, luz de ré, freio
e direcional sequencial

Com triângulo retrorrefletor
para reboques e semirreboques

Com lente em acrílico



TRIPLO
PLUS

Com 76 LEDs



TRIPLO

Com 50 LEDs

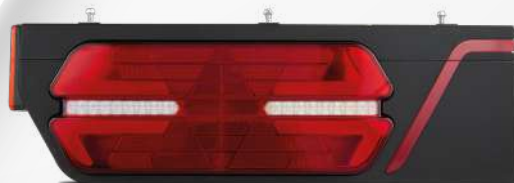

Sem LCM

CÓDIGO	TENSÃO	LADO	EMB.
PL2702.01.67	LED BIVOLT	Direito	01
PL2702.02.67	LED BIVOLT	Esquerdo	01

Com LCM*

CÓDIGO	TENSÃO	LADO	EMB.
PL2702.21.67	LED BIVOLT	Direito	01
PL2702.22.67	LED BIVOLT	Esquerdo	01

CÓDIGO	TENSÃO	LADO	EMB.
PL2702.33.67	LED24V	Direito	01
PL2702.34.67	LED24V	Esquerdo	01

*LCM: Módulo controlador das luzes
direcionais das lanternas laterais.

PL 1452

Lanterna traseira Triplo X PLUS LED
Com 66 LEDs e triângulo retrorrefletor



Com maior visibilidade, LED Bivolt.

Com conector 5 vias e
2 conectores auxiliares 2 vias

Com funções de
posição, luz de ré, freio
e direcional sequencial

Com triângulo retrorrefletor
para reboques e semirreboques

Com lente em acrílico



Sem LCM

CÓDIGO	LADO	EMB.
PL1452.01.47	Direito	01
PL1452.02.47	Esquerdo	01

Com LCM

CÓDIGO	LADO	EMB.
PL1452.21.47	Direito	01
PL1452.22.47	Esquerdo	01

*LCM: Módulo controlador das luzes
direcionais das lanternas laterais.

Mais opções de conexões no caminhão

vista traseira

Lado esquerdo
Conexão 2 vias para alarme
sonoro de ré (uso opcional)

Lado direito
Conexão 2 vias para luz de Posição
ou luz de Placa (uso opcional)

Conexão 5 vias
para as funções Posição,
Seta, Ré e Freio

Conexão 2 vias para luz de Posição
ou luz de Placa (uso opcional)



PL 1452

Lanterna traseira Triplo X LED
Com 40 LEDs e triângulo retrorrefletor



Com conector 5 vias e
2 conectores auxiliares 2 vias

Com funções de posição,
direcional, luz de ré e freio

Com triângulo retrorrefletor
para reboques e semirreboques

Com lente em acrílico



CÓDIGO	TENSÃO	LADO	EMB.
PL1452.11.47	LED 12V	Direito	01
PL1452.12.47	LED 12V	Esquerdo	01
PL1452.33.47	LED 24V	Direito	01
PL1452.34.47	LED 24V	Esquerdo	01

vista frontal

394 MM

vista lateral

80 MM

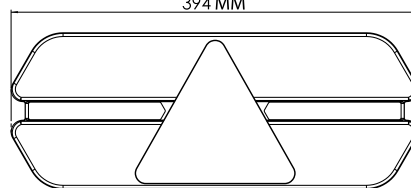

vista superior

250 MM

44,3

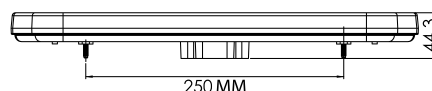

REPOSIÇÃO

Haste ajustável para lanternas PL1452
Fixação ajustável para todos os tipos de carretas



CÓDIGO	EMB.
PL1450.19.17	04

Caixa para suporte Triplo X



CÓDIGO	LADO	EMB.
PL2702.79.17	Direito	01
PL2702.80.17	Esquerdo	01

Chicote universal
Com conector ultra seal 2 vias



CÓDIGO	EMB.
PL9946.17.00	10

Chicote universal
Com conector ultra seal 5 vias e Faston 6,3mm



CÓDIGO	EMB.
PL9953.39.00	10



Personalize com a sua marca

PL 2704

Acabamento traseiro
Produto exclusivo Pradolux

Tecnologia Welcome Light LED's RGB

Espaço central
para personalização
do seu logo.



CÓDIGO
PL2704.00.60

EMB.
01

PERSONALIZÁVEL EXCLUSIVO SOB MEDIDA



CÓDIGO
PL2704.00.63

EMB.
01

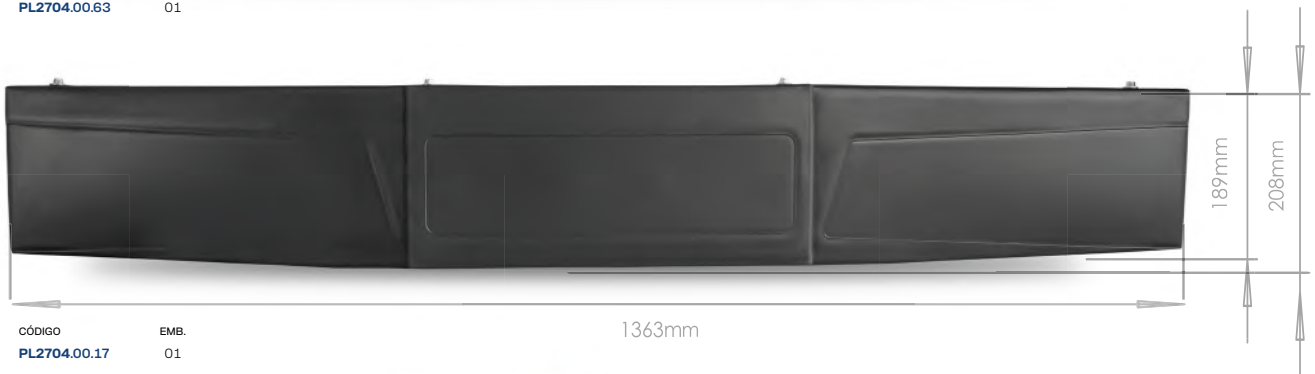

CÓDIGO
PL2704.00.17

EMB.
01

1363mm

189mm

208mm

FALCON



PL 1560

Lanterna traseira LED
Com triângulo retrorrefletor e lente em acrílico para implementos

LED BIVOLT



Botão seletor (touch)



Vista parte traseira

CÓDIGO	LADO	EMB.
PL1560.00.69	Bilateral	01

Bilateral - Selecione o lado da luz indicadora de direção manualmente através de chave seletora.

Lanterna traseira com as funções:
Luz de freio,
Luz de posição,
Luz de direção sequencial,
Luz de marcha à ré

Com 03 conectores auxiliares para:
Luz de placa,
Luz de posição,
Luz de ré.

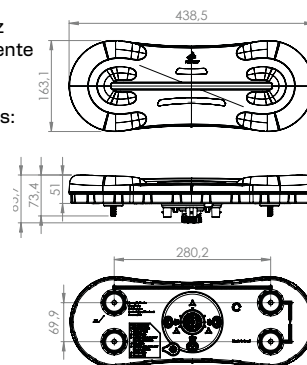

REPOSIÇÃO

Chicote conector Lado esquerdo



CÓDIGO	EMB.
PL9984.42.13	10

Chicote conector Lado direito



CÓDIGO	EMB.
PL9984.41.12	10

Chicote universal Com conector ultra seal 2 vias



CÓDIGO	EMB.
PL9946.17.00	10

PL 2600

Suporte traseiro LED
Com triângulo retrorrefletor e lente em acrílico para implementos

LED BIVOLT



Com conector tipo original



CÓDIGO	LADO	REF. ORIGINAL	EMB.
PL2600.79.69	Direito	0308270335	01
PL2600.80.69	Esquerdo		01

Com cabos para adaptação



CÓDIGO	LADO	EMB.
PL2600.61.69	Direito	01
PL2600.62.69	Esquerdo	01

Com conector tipo original



CÓDIGO	LADO	EMB.
PL2606.79.69	Direito	01
PL2606.80.69	Esquerdo	01

PL 2606

Suporte traseiro LED
Com triângulo retrorrefletor, lente em acrílico e conector tipo original para implementos

LED BIVOLT

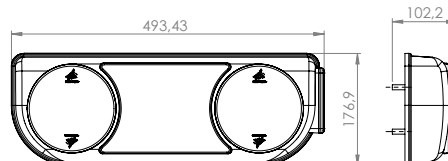

REPOSIÇÃO

Lanterna com 19 LEDs
Com lente em acrílico
Aplicação universal

140mm

LED BIVOLT



CÓDIGO	EMB.
PL0820.00.65	05



CÓDIGO	EMB.
PL0820.00.67	05

Triângulo retrorrefletor
Lente em acrílico



CÓDIGO	EMB.
PL0731.00.23	10

Chicote conector Lado esquerdo



CÓDIGO	EMB.
PL9984.42.13	10

Chicote conector Lado direito



CÓDIGO	EMB.
PL9984.41.12	10

PL 2102

Suporte traseiro LED
Com lente em acrílico
Aplicação Noma e universal

LED24V



CÓDIGO	LADO	EMB.
PL2102.77.69	Direito	01
PL2102.78.69	Esquerdo	01

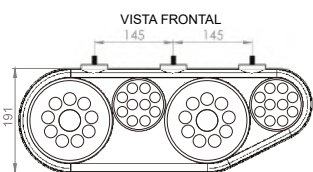

VISTA LATERAL



PL 2104

Suporte traseiro LED
Com triângulo retrorrefletor e lente em acrílico
Aplicação Noma e universal

LED24V



CÓDIGO	LADO	REF. ORIGINAL	EMB.
PL2104.75.69	Direito	9205586	01
PL2104.76.69	Esquerdo	9205585	01

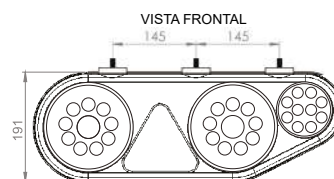

REPOSIÇÃO

Lanterna com 10 LEDs

Com lente em acrílico
Para suporte traseiro



LED24V



CÓDIGO	EMB.	CÓDIGO	EMB.
PL0780.24.63	04	PL0788.24.67	04

Lanterna com 10 LEDs

Com lente em acrílico
Para suporte traseiro

LED BIVOLT



CÓDIGO	COR	EMB.
PL0782.00.61	Amarelo	01
PL0782.00.62	Cristal	01

Triângulo retrorrefletor

Lente em acrílico



CÓDIGO	EMB.
PL0790.00.23	10

Chicote 2 vias Para Faston 6,3mm



CÓDIGO	EMB.
PL9950.17.00	10

Chicote 3 vias Para Faston 6,3mm



CÓDIGO	EMB.
PL9951.37.00	10

PL 0731

Triângulo retrorrefletor em acrílico



CÓDIGO	EMB.
PL0731.00.23	10

Com parafuso de fixação 2 ou 3 furos

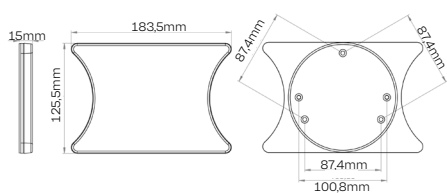

PL 0790

Triângulo retrorrefletor em acrílico



CÓDIGO	EMB.
PL0790.00.23	10

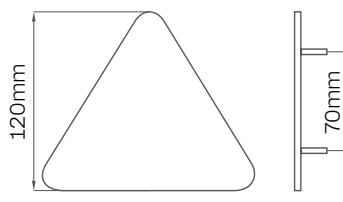

PL 0994

Triângulo retrorrefletor em acrílico



CÓDIGO	LADO	EMB.
PL0994.01.23	Direito	04
PL0994.02.23	Esquerdo	04

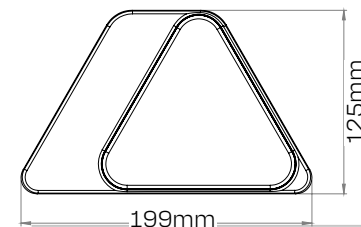

PL 2300

Suporte traseiro com LED **LED24V**
Aplicação universal

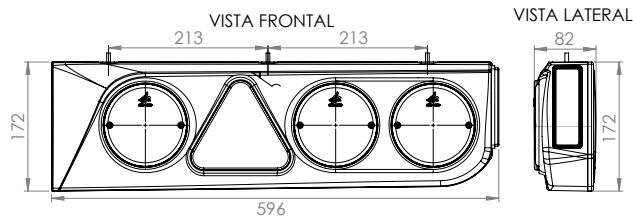

CÓDIGO	LADO	REF. ORIGINAL	EMB.
PL2300.33.69	Direito	9512576	01
PL2300.34.69	Esquerdo	9512577	01

REPOSIÇÃO

Lanterna com 10 LEDs

Com lente em acrílico
Para suporte traseiro aplicação Librelato

LED24V



CÓDIGO	EMB.	CÓDIGO	EMB.	CÓDIGO	EMB.
PL0796.24.61	05	PL0796.24.62	05	PL0796.24.63	05

Triângulo retrorrefletor

Lente em acrílico



CÓDIGO	EMB.
PL0790.00.23	10

Chicote 2 vias Para Faston 6,3mm



CÓDIGO	EMB.
PL9950.17.00	10

Chicote 3 vias Para Faston 6,3mm



CÓDIGO	EMB.
PL9951.37.00	10

PL 2304

Suporte traseiro com LED **LED24V**
Aplicação universal

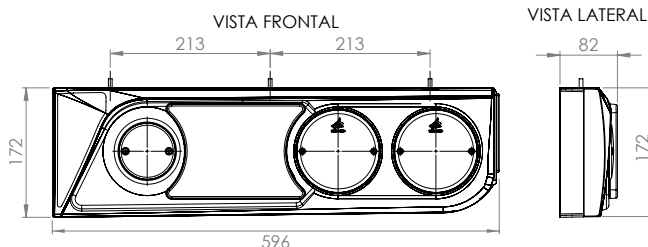

CÓDIGO	LADO	REF. ORIGINAL	EMB.
PL2304.33.69	Direito	9517157	01
PL2304.34.69	Esquerdo	9517156	01

REPOSIÇÃO

Lanterna com 10 LEDs

Com lente cristal em acrílico

LED24V



CÓDIGO	EMB.	CÓDIGO	EMB.
PL0798.24.61	05	PL0798.24.63	05

Lanterna com 4 LEDs

Com lente em acrílico

LED24V



CÓDIGO	EMB.
PL0800.00.62	10

Triângulo retrorrefletor

Lente em acrílico



CÓDIGO	EMB.
PL0731.00.23	10

Chicote 2 vias Para Faston 6,3mm



CÓDIGO	EMB.
PL9950.17.00	10

Chicote 3 vias Para Faston 6,3mm



CÓDIGO	EMB.
PL9951.37.00	10

Chicote universal Com conector ultra seal 2 vias



CÓDIGO	EMB.
PL9946.17.00	10

PL 2010

Suporte traseiro polivalente
Aplicação Facchini



REPOSIÇÃO

Lanterna traseira com fixação frontal para suporte implementos e ônibus



CÓDIGO	EMB.
PL0582.00.01	10



CÓDIGO	EMB.
PL0582.00.02	10



CÓDIGO	EMB.
PL0582.00.23	10

P21W (1141)
Freio
Luz de ré
Direcional

P21/5W (1034)
Freio e Posição

Não acompanha lâmpada

CÓDIGO	LADO	EMB.
PL2010.60.09	Bilateral	01

Lanterna Aplicação lateral

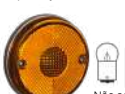

CÓDIGO	EMB.
PL0526.21.01	10

Lente para lanterna lateral



CÓDIGO	EMB.
PL0531.00.01	10

Soquete 1 polo Universal



CÓDIGO	EMB.
PL9900.17.94	10

Chicote 2 vias Para Faston 6,3mm



CÓDIGO	EMB.
PL9950.17.00	10

Chicote 3 vias Para Faston 6,3mm



CÓDIGO	EMB.
PL9951.37.00	10

PL 2058

Suporte traseiro 10 LEDs com triângulo
Aplicação universal

LED BIVOLT



CÓDIGO	LADO	EMB.
PL2058.65.70	Direito	01
PL2058.66.70	Esquerdo	01

PL 2066

Suporte traseiro 10 LEDs
Aplicação universal

LED BIVOLT



CÓDIGO	LADO	EMB.
PL2066.77.69	Direito	01
PL2066.78.69	Esquerdo	01

PL 2070

Suporte traseiro 10 LEDs
Aplicação universal

LED BIVOLT



CÓDIGO	LADO	EMB.
PL2070.33.69	Direito	01
PL2070.34.69	Esquerdo	01

PL 2076

Suporte traseiro 10 LEDs com triângulo
Aplicação universal

LED BIVOLT



CÓDIGO	LADO	EMB.
PL2076.75.69	Direito	01
PL2076.76.69	Esquerdo	01

REPOSIÇÃO

Lanterna com 10 LEDs

Com lente em acrílico para suporte traseiro aplicação universal

125mm

LED BIVOLT



1 polo



1 polo



2 polos

CÓDIGO	EMB.	CÓDIGO	EMB.	CÓDIGO	EMB.
PL0760.00.61	01	PL0760.00.62	01	PL0760.00.63	01

Lanterna

Com lente lisa



125mm

CÓDIGO	EMB.
PL0756.23.04	10

Lanterna

Com retrorefletor



125mm

CÓDIGO	EMB.
PL0758.00.07	10

Lanterna LED

Aplicação lateral com cabos e lente acrílica



66mm

CÓDIGO	EMB.
PL0578.00.61	10

Triângulo retrorefletor

Lente em acrílico



CÓDIGO	EMB.
PL0731.00.23	10

Caixa para suporte traseiro



CÓDIGO	LADO	EMB.
PL2000.61.17	Direito	01
PL2000.62.17	Esquerdo	01

Soquete 1 polo Universal

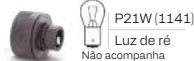

CÓDIGO	EMB.
PL9900.17.94	10

Chicote 2 vias Para Faston 6,3mm



CÓDIGO	EMB.
PL9950.17.00	10

Chicote 3 vias Para Faston 6,3mm



CÓDIGO	EMB.
PL9951.37.00	10

PL 2000

Suporte traseiro
Aplicação universal



CÓDIGO	LADO	REF. ORIGINAL	EMB.
PL2000.61.09	Direito	210102003-P	01
PL2000.62.09	Esquerdo	210102004-P	01

REPOSIÇÃO

Lanterna universal para suporte traseiro



CÓDIGO	EMB.
PL0526.00.01	10



CÓDIGO	EMB.
PL0526.00.03	10

125mm

Lanterna Com retrorefletor



CÓDIGO	EMB.
PL0758.00.07	10

P21W (1141)
Freio
Luz de ré
Direcional

P21/5W (1034)
Freio e Posição

Não acompanha lâmpada

Lanterna

Aplicação lateral



85mm

RSW (67)
Posição

Não acompanha lâmpada

CÓDIGO	EMB.
PL0526.21.01	10

Lente para lanterna lateral



CÓDIGO	EMB.
PL0531.00.01	10



CÓDIGO	LADO	EMB.
PL2000.61.17	Direito	01
PL2000.62.17	Esquerdo	01

Soquete 1 polo Universal



CÓDIGO	EMB.
PL9900.17.94	10

Chicote 2 vias Para Faston 6,3mm



CÓDIGO	EMB.
PL9950.17.00	10

Chicote 3 vias Para Faston 6,3mm



CÓDIGO	EMB.
PL9951.37.00	10

PL 2038

Suporte traseiro com triângulo e ré fumê
Aplicação universal



CÓDIGO	LADO	EMB.
PL2038.65.10	Direito	01
PL2038.66.10	Esquerdo	01

PL 2040

Suporte traseiro
Aplicação universal



CÓDIGO	LADO	EMB.
PL2040.61.10	Direito	01
PL2040.62.10	Esquerdo	01

PL 2048

Suporte traseiro com triângulo
Aplicação universal



CÓDIGO	LADO	EMB.
PL2048.65.09	Direito	01
PL2048.66.09	Esquerdo	01

PL 2050

Suporte traseiro com luz de ré vermelho e cristal
Aplicação universal



CÓDIGO	LADO	REF. ORIGINAL	EMB.
PL2050.61.09	Direito	210102691-P	01
PL2050.62.09	Esquerdo	210102692-P	01

REPOSIÇÃO

Lanterna com lente lisa
para suporte implementos e ônibus



CÓDIGO	EMB.	CÓDIGO	EMB.	CÓDIGO	EMB.	CÓDIGO	EMB.
PL0756.23.01	10	PL0756.23.02	10	PL0756.23.03	10	PL0756.23.04	10

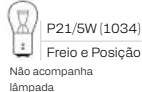
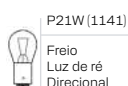

Lanterna
Com retrorrefletor



CÓDIGO	EMB.	CÓDIGO	EMB.
PL0758.00.07	10	PL0758.00.08	10

Lanterna
Aplicação lateral



CÓDIGO	EMB.
PL0526.21.01	10

Triângulo
retrorefletor
Lente em acrílico



CÓDIGO	EMB.
PL0731.00.23	10

Caixa para suporte traseiro



CÓDIGO	LADO	EMB.
PL2000.61.17	Direito	01
PL2000.62.17	Esquerdo	01

Soquete 1 polo
Universal



CÓDIGO	EMB.
PL9900.17.94	10

Soquete 2 polos
Universal



CÓDIGO	EMB.
PL9901.37.94	10

Chicote 2 vias
Para Faston 6,3mm



CÓDIGO	EMB.
PL9950.17.00	10

Chicote 3 vias
Para Faston 6,3mm



CÓDIGO	EMB.
PL9951.37.00	10

PL 9960

Simulador de carga
para instalação de lanternas LED



CÓDIGO	EMB.
PL9960.00.00	10

- Uso bivolt 12 - 24V. Aplicação somente em corrente contínua;
- Proteção e estabilidade de sinalização;
- Carcaça selada a prova d'água;
- Fácil instalação com cabo 7 vias.
- Com 3 Saídas auxiliares:
 - Aux. 1 - Freio;
 - Aux. 2 - Luz de ré;
 - Aux. 3 - Posição (ambos os lados)

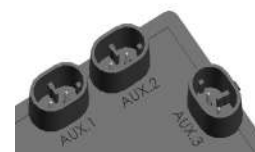

Para conectar na tomada 7 pinos do cabo principal do kit elétrico de acordo com norma 1185.

Simulador de carga eletrônico para implementação de lanternas LED em implementos rodoviários.

Com correção de reconhecimento pelo veículo e estabilidade da luminosidade.

COR	FUNÇÃO
TERRA (-)	
POSICÃO D	
LUZ DE RÉ	
DIRECIONAL D	
FREIO	
DIRECIONAL E	
POSICÃO E	

PL 2004

Suporte traseiro
Aplicação Guerra e universal



CÓDIGO	LADO	REF. ORIGINAL	EMB.
PL2004.61.09	Direito	5001009206009	01
PL2004.62.09	Esquerdo	5001009207000	01

PL 2008

Suporte traseiro com lente lisa
Aplicação Guerra e universal



CÓDIGO	LADO	EMB.
PL2008.61.09	Direito	01
PL2008.62.09	Esquerdo	01

REPOSIÇÃO

Lanterna

para implementos aplicação Guerra



CÓDIGO	EMB.
PL0536.00.01	10



CÓDIGO	EMB.
PL0536.00.02	10



CÓDIGO	EMB.
PL0536.00.03	10

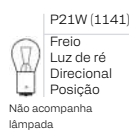

Lanterna com lente lisa

para implementos aplicação Guerra



CÓDIGO	EMB.
PL0586.00.01	10



CÓDIGO	EMB.
PL0586.00.02	10



CÓDIGO	EMB.
PL0586.00.03	10

Lanterna Aplicação lateral



CÓDIGO	EMB.
PL0564.00.01	10



Lente para lanterna lateral



CÓDIGO	EMB.
PL0565.00.01	10

Caixa para suporte traseiro



CÓDIGO	LADO	EMB.
PL2004.61.17	Direito	01
PL2004.62.17	Esquerdo	01

Soquete 1 polo Universal



CÓDIGO	EMB.
PL9900.17.94	10

Chicote 2 vias Para Faston 6,3mm



CÓDIGO	EMB.
PL9950.17.00	10

PL 9964

Suporte de placa de identificação veicular
Multifunção

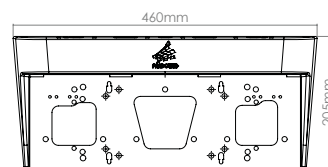

Também aplicável para lanternas



CÓDIGO	EMB.
PL9964.19.17	06

PL 9966

Suporte de placa de painéis de segurança

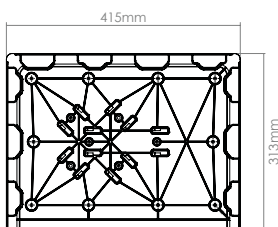

CÓDIGO	EMB.
PL9966.19.17	06

PL 9968

Suporte de placa de rótulos de risco

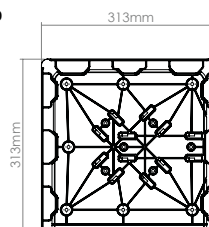

CÓDIGO	EMB.
PL9968.19.17	06

PL 0200

Lanterna traseira LED com borda emborrachada para fixação
Modelo americano com 10 LED's

Com conector



Direcional
CÓDIGO TENSÃO EMB.
PL0200.41.41 LED BIVOLT 10



Luz de ré
CÓDIGO TENSÃO EMB.
PL0200.41.42 LED BIVOLT 10



Freio e posição
CÓDIGO TENSÃO EMB.
PL0200.41.43 LED BIVOLT 10



Vista parte traseira

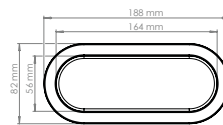

Com cabos - 3 fios



Direcional
CÓDIGO TENSÃO EMB.
PL0200.49.41 LED BIVOLT 10



Luz de ré
CÓDIGO TENSÃO EMB.
PL0200.49.42 LED BIVOLT 10



Freio e posição
CÓDIGO TENSÃO EMB.
PL0200.49.43 LED BIVOLT 10



Vista parte traseira

REPOSIÇÃO

Chicote 3 vias para Lanterna Americana



REPOSIÇÃO EMB.
PL9903.37.00 10

PL 0202

Lanterna delimitadora LED com borda emborrachada para fixação
Modelo americano com 4 LED's

Com conector

72mm



CÓDIGO TENSÃO EMB.
PL0202.41.41 LED BIVOLT 10



CÓDIGO TENSÃO EMB.
PL0202.41.42 LED BIVOLT 10



CÓDIGO TENSÃO EMB.
PL0202.41.43 LED BIVOLT 10



Vista parte traseira

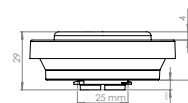
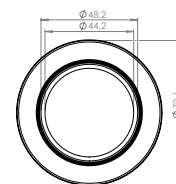

Com cabos



CÓDIGO TENSÃO EMB.
PL0202.49.41 LED BIVOLT 10



CÓDIGO TENSÃO EMB.
PL0202.49.42 LED BIVOLT 10



CÓDIGO TENSÃO EMB.
PL0202.49.43 LED BIVOLT 10



Vista parte traseira

REPOSIÇÃO

Chicote 2 vias para Lanterna Americana



REPOSIÇÃO EMB.
PL9909.17.00 10

PL 0204

Lanterna traseira LED com borda emborrachada para fixação
Modelo americano com 10 LED's

Com conector

137mm



CÓDIGO TENSÃO EMB.
PL0204.41.41 LED BIVOLT 10



CÓDIGO TENSÃO EMB.
PL0204.41.42 LED BIVOLT 10



CÓDIGO TENSÃO EMB.
PL0204.41.43 LED BIVOLT 10



Vista parte traseira

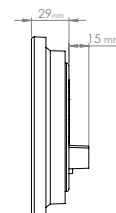
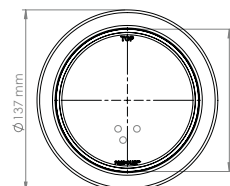

Com cabos



CÓDIGO TENSÃO EMB.
PL0204.49.41 LED BIVOLT 10



CÓDIGO TENSÃO EMB.
PL0204.49.42 LED BIVOLT 10



CÓDIGO TENSÃO EMB.
PL0204.49.43 LED BIVOLT 10



Vista parte traseira

REPOSIÇÃO

Chicote 3 vias para Lanterna Americana



REPOSIÇÃO EMB.
PL9903.37.00 10

PL 0820

Lanternas LED com 19 LEDs Bivolt
Aplicação universal
Com lente em acrílico

LED BIVOLT
140mm



CÓDIGO	EMB.	CÓDIGO	EMB.	CÓDIGO	EMB.
PL0820.00.65	05	PL0820.00.67	05	PL0820.00.69	05

PL 0806

Lanternas Halo Light
com 02 funções
Com lente em acrílico

LED 24V
125mm

LINHA HALO LIGHT™



CÓDIGO	EMB.	CÓDIGO	EMB.	CÓDIGO	EMB.
PL0806.24.65	01	PL0806.24.67	01	PL0806.24.63	01

PL 0760

Lanterna com 10 LEDs
Com lente em acrílico
para suporte traseiro aplicação universal

LED BIVOLT
125mm



CÓDIGO	EMB.	CÓDIGO	EMB.	CÓDIGO	EMB.
PL0760.00.61	02	PL0760.00.62	02	PL0760.00.63	02

PL 0762

Lanterna com 10 LEDs
Com lente em acrílico
para suporte traseiro aplicação universal

LED BIVOLT
125mm



CÓDIGO	EMB.	CÓDIGO	EMB.	CÓDIGO	EMB.
PL0762.00.61	02	PL0762.00.62	02	PL0762.00.63	02

PL 0796

Lanterna com 10 LEDs
Com lente em acrílico
para suporte traseiro aplicação Librelato

LED 24V
110mm



CÓDIGO	EMB.	CÓDIGO	EMB.	CÓDIGO	EMB.
PL0796.24.61	05	PL0796.24.62	05	PL0796.24.63	05
REF. ORIGINAL	9701630	REF. ORIGINAL	9513079	REF. ORIGINAL	9513082

PL 0798

Lanterna com 10 LEDs
Com lente em acrílico
para suporte traseiro aplicação Librelato

LED 24V
110mm



CÓDIGO	EMB.	CÓDIGO	EMB.
PL0798.24.61	05	PL0798.24.63	05
REF. ORIGINAL	9701075	REF. ORIGINAL	9701074

REPOSIÇÃO

Chicote 2 vias
Para Faston 6,3mm



CÓDIGO	EMB.
PL9950.17.00	10

Chicote 3 vias
Para Faston 6,3mm



CÓDIGO	EMB.
PL9951.37.00	10

PL 0782

Lanterna com 10 LEDs
Com lente em acrílico
para suporte traseiro aplicação Noma e Librelato

LED BIVOLT
96mm



CÓDIGO	EMB.	CÓDIGO	EMB.	CÓDIGO	EMB.
PL0782.00.61	02	PL0782.00.62	02	PL0782.00.63	02

REPOSIÇÃO

Chicote 2 vias
Para Faston 6,3mm



CÓDIGO	EMB.
PL9950.17.00	10

Chicote 3 vias
Para Faston 6,3mm



CÓDIGO	EMB.
PL9951.37.00	10

PL 0800

Lanterna com 4 LEDs
Com lente em acrílico
para suporte traseiro tipo Librelato

LED 24V
75mm



CÓDIGO	EMB.
PL0800.00.62	10
REF. ORIGINAL	9701076

REPOSIÇÃO

Chicote universal
Com conector
ultra seal 2 vias



CÓDIGO	EMB.
PL9946.17.00	10

PL 0780

Lanterna com 10 LEDs 2 funções
Com lente em acrílico
para suporte traseiro aplicação Noma



155mm

LED 24V

2 polos

REPOSIÇÃO

Chicote 3 vias
Para Faston 6,3mm



CÓDIGO EMB.
PL0780.24.63 04

CÓDIGO EMB.
PL9951.37.00 10

PL 0788

Lanterna com 10 LEDs 3 funções
Com lente em acrílico
para suporte traseiro aplicação Noma



155mm

LED 24V

4 polos

CÓDIGO EMB.
PL0788.24.67 04

PL 0536

Lanterna
para implementos aplicação Guerra



CÓDIGO EMB.
PL0536.00.01 10

CÓDIGO EMB.
PL0536.00.02 10

CÓDIGO EMB.
PL0536.00.03 10

CÓDIGO EMB.
PL0586.00.01 10

CÓDIGO EMB.
PL0586.00.02 10

CÓDIGO EMB.
PL0586.00.03 10

REF. ORIGINAL 5001009213001

REF. ORIGINAL 5001009154009

REF. ORIGINAL 5001009211008

REPOSIÇÃO

Soquete com 1 polo



CÓDIGO EMB.
PL9900.17.94 10

Soquete com 2 polos



CÓDIGO EMB.
PL9901.37.94 10

Chicote 2 vias



CÓDIGO EMB.
PL9950.17.00 10

Chicote 3 vias



CÓDIGO EMB.
PL9951.37.00 10

P21W (1141)
Freio
Luz de ré
Direcional

P21/SW (1034)
Freio e Posição
Não acompanha lâmpada

PL 0756

Lanterna com lente lisa
aplicação ônibus e implementos

125mm



CÓDIGO EMB.
PL0756.23.01 10

CÓDIGO EMB.
PL0756.23.02 10

CÓDIGO EMB.
PL0756.23.03 10

CÓDIGO EMB.
PL0756.23.04 10

CÓDIGO EMB.
PL0758.00.07 10

CÓDIGO EMB.
PL0758.00.08 10

REF. ORIGINAL 213000113

REF. ORIGINAL 213000112

REF. ORIGINAL 213000114

REPOSIÇÃO

Soquete com 1 polo



CÓDIGO EMB.
PL9900.17.94 10

Soquete com 2 polos



CÓDIGO EMB.
PL9901.37.94 10

Chicote 2 vias



CÓDIGO EMB.
PL9950.17.00 10

Chicote 3 vias



CÓDIGO EMB.
PL9951.37.00 10

P21W (1141)
Freio
Luz de ré
Direcional

P21/SW (1034)
Freio e Posição
Direcional e Posição
Não acompanha lâmpada

PL 0526

Lanterna universal
e aplicação em suportes traseiros



CÓDIGO	EMB.	CÓDIGO	EMB.	CÓDIGO	EMB.
PL0526.00.01	10	PL0526.00.02	10	PL0526.00.03	10

REF. ORIGINAL 210102062

PL 0582

Lanterna com lente lisa
Fixação frontal
aplicação ônibus e implementos



CÓDIGO	EMB.	CÓDIGO	EMB.	CÓDIGO	EMB.
PL0582.00.01	10	PL0582.00.02	10	PL0582.00.23	10

REF. ORIGINAL 92210025001

REF. ORIGINAL 92210026001

REF. ORIGINAL 92210024001

PL 1354

Lanterna traseira com fixação frontal
aplicação ônibus e implementos



CÓDIGO	EMB.	CÓDIGO	EMB.	CÓDIGO	EMB.
PL1354.00.01	10	PL1354.00.02	10	PL1354.00.03	10

REF. ORIGINAL 6233239M91

REF. ORIGINAL 6233240M91

REPOSIÇÃO

Soquete com
1 polo



CÓDIGO	EMB.
PL9900.17.94	10

Soquete com
2 polos



CÓDIGO	EMB.
PL9901.37.94	10

Chicote 2 vias



CÓDIGO	EMB.
PL9950.17.00	10

Chicote 3 vias



CÓDIGO	EMB.
PL9951.37.00	10

P21W (1141)
Freio
Luz de ré
Direcional

P21/SW (1034)
Freio e Posição
Direcional e Posição
Não acompanha lâmpada

PL 0578

Lanterna lateral LED com cabos
Com lente em acrílico



LED BIVOLT



CÓDIGO	EMB.	CÓDIGO	EMB.	CÓDIGO	EMB.	CÓDIGO	EMB.
PL0578.00.61	10	PL0578.00.62	10	PL0578.00.63	10	PL0578.00.72	10

PL 0678

Lanterna lateral LED com conector
Com lente em acrílico



LED BIVOLT



CÓDIGO	EMB.	CÓDIGO	EMB.	CÓDIGO	EMB.	CÓDIGO	EMB.
PL0678.41.61	10	PL0678.41.62	10	PL0678.41.63	10	PL0678.41.72	10

Vista parte traseira

REPOSIÇÃO

Chicote universal
Com conector
ultra seal 2 vias



CÓDIGO	EMB.
PL9946.17.00	10

Com conector
ultra seal 2 vias e
conector Faston



CÓDIGO	EMB.
PL9946.41.00	10

PL 0584

Lanterna lateral LED
com haste e cabos
Com lente em acrílico



LED BIVOLT



CÓDIGO	EMB.	CÓDIGO	EMB.	CÓDIGO	EMB.
PL0584.19.61	10	PL0584.19.62	10	PL0584.19.17	10
PL0584.19.63	10	PL0584.19.72	10		

REPOSIÇÃO

Haste
Para lanternas
66mm



PL 0684

Lanterna lateral LED
com haste e conector
Com lente em acrílico



LED BIVOLT



CÓDIGO	EMB.	CÓDIGO	EMB.	CÓDIGO	EMB.
PL0684.19.61	10	PL0684.19.62	10	PL0684.19.17	10
PL0684.19.63	10	PL0684.19.72	10		

REPOSIÇÃO

Chicote universal
Com conector
ultra seal 2 vias



CÓDIGO	EMB.
PL9946.17.00	10

Com conector
ultra seal 2 vias e
conector Faston



CÓDIGO	EMB.
PL9946.41.00	10

PL 0312

Lanterna lateral LED com cabos
Com lente em acrílico
Para parafuso passante



LED BIVOLT



CÓDIGO EMB.
PL0312.00.61 10



CÓDIGO EMB.
PL0312.00.62 10



Vista parte traseira



CÓDIGO EMB.
PL0312.00.63 10



CÓDIGO EMB.
PL0312.00.72 10

PL 0412

Lanterna lateral LED com conector
Com lente em acrílico
Para parafuso passante



LED BIVOLT



CÓDIGO EMB.
PL0412.41.61 10



CÓDIGO EMB.
PL0412.41.62 10



CÓDIGO EMB.
PL0412.41.63 10

REF. ORIGINAL 04124162

REPOSIÇÃO



Vista parte traseira

Chicote universal
Com conector ultra seal 2 vias



CÓDIGO EMB.
PL9946.17.00 10

Com conector ultra seal 2 vias e conector Faston



CÓDIGO EMB.
PL9946.41.00 10

PL 0526

Lanterna universal
e aplicação em suportes traseiros



Com conector



CÓDIGO EMB.
PL0526.21.01 10



CÓDIGO EMB.
PL0526.21.02 10



CÓDIGO EMB.
PL0526.21.03 10

REF. ORIGINAL 210102016

REF. ORIGINAL 210102019

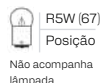

RSW (67)
Posição
Não acompanha lâmpada

Com base reta e LED BIVOLT



CÓDIGO EMB.
PL0526.15.41 10



CÓDIGO EMB.
PL0526.15.42 10



CÓDIGO EMB.
PL0526.15.43 10

PL 0524

Lanterna lateral universal com haste



Com conector



CÓDIGO EMB.
PL0524.19.01 10



CÓDIGO EMB.
PL0524.19.02 10



CÓDIGO EMB.
PL0524.19.03 10



Vista parte traseira

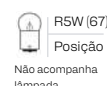

RSW (67)
Posição
Não acompanha lâmpada

Com base reta e LED BIVOLT



CÓDIGO EMB.
PL0524.15.41 10



CÓDIGO EMB.
PL0524.15.42 10



CÓDIGO EMB.
PL0524.15.43 10



Vista parte traseira

Haste para lanternas 86mm



REPOSIÇÃO EMB.
PL0524.19.17 10

Chicote 2 vias



REPOSIÇÃO EMB.
PL9948.17.00 10

REPOSIÇÃO

Lente para lanterna lateral



REPOSIÇÃO EMB.
PL0531.00.01 10



REPOSIÇÃO EMB.
PL0531.00.02 10



REPOSIÇÃO EMB.
PL0531.00.03 10

PL 0566

Lanterna lateral universal com haste
Aplicação Guerra



Com base reta e LED BIVOLT



CÓDIGO EMB.
PL0566.15.41 10



CÓDIGO EMB.
PL0566.15.42 10



CÓDIGO EMB.
PL0566.15.43 10



Vista parte traseira

PL 0564

Lanterna universal
Aplicação Guerra



Com base reta e LED BIVOLT



CÓDIGO EMB.
PL0564.15.41 10



CÓDIGO EMB.
PL0564.15.42 10



CÓDIGO EMB.
PL0564.15.43 10

REPOSIÇÃO

Lente
Para lanterna lateral



REPOSIÇÃO EMB.
PL0565.00.01 10



REPOSIÇÃO EMB.
PL0565.00.02 10



REPOSIÇÃO EMB.
PL0565.00.03 10



REPOSIÇÃO EMB.
PL0524.19.17 10

Haste
Para lanternas 86mm

PL 0638

Lanterna lateral com 2 LEDs e conector



CÓDIGO	EMB.	CÓDIGO	EMB.	CÓDIGO	EMB.	Vista parte traseira
PL0638.41.41	10	PL0638.41.42	10	PL0638.41.43	10	

PL 0646

Lanterna lateral com 2 LEDs, haste e conector



CÓDIGO	EMB.	CÓDIGO	EMB.	CÓDIGO	EMB.	Vista parte traseira
PL0646.19.41	10	PL0646.19.42	10	PL0646.19.43	10	

REPOSIÇÃO

Chicote universal Com conector ultra seal 2 vias

CÓDIGO	EMB.
PL9946.17.00	10



Chicote universal Com conector ultra seal 2 vias e conector Faston

CÓDIGO	EMB.
PL9946.41.00	10



Haste Para lanternas 85mm

CÓDIGO	EMB.
PL0524.19.17	10



PL 0538

Lanterna lateral com 2 LED's Para parafuso passante



CÓDIGO	EMB.	CÓDIGO	EMB.
PL0538.31.61	10	PL0538.31.62	10



CÓDIGO	EMB.	Vista parte traseira
PL0538.31.63	10	

PL 0590

Lanterna lateral com 2 LEDs blindada Com parafusos soberbos



CÓDIGO	EMB.	CÓDIGO	EMB.	Vista parte traseira
PL0590.00.41	10	PL0590.00.42	10	



CÓDIGO	EMB.	CÓDIGO	EMB.
PL0590.00.43	10	PL0590.00.52	10

PL 0690

Lanterna lateral com 2 LEDs blindada



CÓDIGO	EMB.	CÓDIGO	EMB.	Vista parte traseira
PL0690.00.41	10	PL0690.00.42	10	



CÓDIGO	EMB.	CÓDIGO	EMB.
PL0690.00.43	10	PL0690.00.52	10

PL 0688

Lanterna lateral com 2 LEDs e haste acoplada



CÓDIGO	EMB.	CÓDIGO	EMB.	Vista parte traseira
PL0688.00.41	10	PL0688.00.42	10	



CÓDIGO	EMB.	CÓDIGO	EMB.
PL0688.00.43	10	PL0688.00.52	10

PL 0656

Lanterna lateral exclusiva com conector 2 vias
 MODELO STANDARD - Com 10 LEDs
 Aplicação universal



Com suporte



CÓDIGO	EMB.	CÓDIGO	EMB.	CÓDIGO	EMB.	CÓDIGO	EMB.	CÓDIGO	EMB.	CÓDIGO	EMB.
PL0656.41.61	10	PL0656.41.62	10	PL0656.41.63	10	PL0656.19.61	10	PL0656.19.62	10	PL0656.19.63	10

Com vigia + 4 LEDs

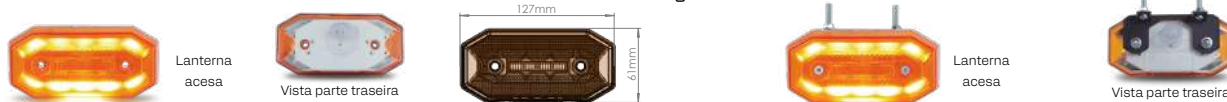

PL 0660

Lanterna lateral exclusiva com conector 2 vias
 MODELO PLUS - Com 16 LEDs
 Aplicação universal



Com suporte



CÓDIGO	EMB.	CÓDIGO	EMB.	CÓDIGO	EMB.	CÓDIGO	EMB.	CÓDIGO	EMB.	CÓDIGO	EMB.
PL0660.41.61	10	PL0660.41.62	10	PL0660.41.63	10	PL0660.19.61	10	PL0660.19.62	10	PL0660.19.63	10

Com vigia + 4 LEDs

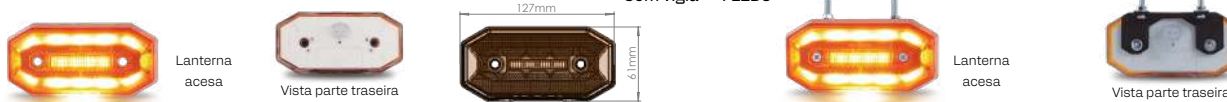

PL 0640

Lanterna lateral SLIM com guia de luz LED
 Aplicação Universal
 Com lente em acrílico



Com cabos para conexão



CÓDIGO	EMB.
PL0640.00.61	10



CÓDIGO	EMB.
PL0640.00.62	10



CÓDIGO	EMB.
PL0640.00.63	10

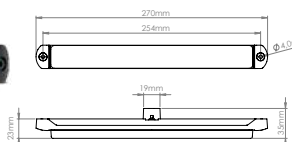

Com conector



CÓDIGO	EMB.
PL0640.41.61	10



CÓDIGO	EMB.
PL0640.41.62	10



CÓDIGO	EMB.
PL0640.41.63	10

REPOSIÇÃO

Chicote universal
 Com conector
 ultra seal 2 vias



CÓDIGO	EMB.
PL9946.17.00	10

Com conector
 ultra seal 2 vias e
 conector Faston



CÓDIGO	EMB.
PL9946.41.00	10

PL 0642

Lanterna lateral SLIM com guia de luz LED e suporte
 Aplicação Universal
 Com lente em acrílico



Com suporte e cabos para conexão



CÓDIGO	EMB.
PL0642.00.61	10



CÓDIGO	EMB.
PL0642.00.62	10



CÓDIGO	EMB.
PL0642.00.63	10



Vista parte traseira



Vista parte traseira

Com suporte e conector



CÓDIGO	EMB.
PL0642.41.61	10



CÓDIGO	EMB.
PL0642.41.62	10



CÓDIGO	EMB.
PL0642.41.63	10

IMPLEMENTOS

PL 0670

Lanterna lateral LED
Aplicação Universal
Com lente em acrílico e cabos para conexão



CÓDIGO EMB.
PL0670.00.61 10



CÓDIGO EMB.
PL0670.00.63 10



CÓDIGO EMB.
PL0670.00.62 10



Vista parte traseira

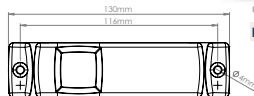

PL 0672

Lanterna lateral LED com suporte
Aplicação Universal
Com lente em acrílico e cabos para conexão



CÓDIGO EMB.
PL0672.19.61 10



CÓDIGO EMB.
PL0672.19.63 10



CÓDIGO EMB.
PL0672.19.62 10



Vista parte traseira



PL 0674

Lanterna lateral com 2 LED's
Aplicação universal

Com base reta e cabos



CÓDIGO EMB.
PL0674.00.41 10



CÓDIGO EMB.
PL0674.00.42 10



CÓDIGO EMB.
PL0674.00.43 10

LED BIVOLT



Vista parte traseira

Base reta, cabos e haste



CÓDIGO EMB.
PL0674.30.41 10



CÓDIGO EMB.
PL0674.30.42 10



CÓDIGO EMB.
PL0674.30.43 10



Vista parte traseira

Com conector



CÓDIGO EMB.
PL0674.41.41 10



CÓDIGO EMB.
PL0674.41.42 10



CÓDIGO EMB.
PL0674.41.43 10



Vista parte traseira

Com conector e haste



CÓDIGO EMB.
PL0674.19.41 10



CÓDIGO EMB.
PL0674.19.42 10



CÓDIGO EMB.
PL0674.19.43 10



Vista parte traseira

PL 0676

Lanterna lateral com 2 LED's
Aplicação universal

LED BIVOLT

Com base reta e cabos



CÓDIGO EMB.
PL0676.00.41 10

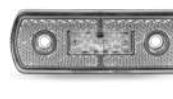

CÓDIGO EMB.
PL0676.00.42 10



CÓDIGO EMB.
PL0676.00.43 10



Vista parte traseira

Base reta, cabos e haste



CÓDIGO EMB.
PL0676.30.41 10



CÓDIGO EMB.
PL0676.30.42 10



CÓDIGO EMB.
PL0676.30.43 10



Vista parte traseira

Com conector



CÓDIGO EMB.
PL0676.41.41 10

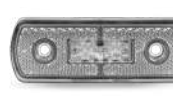

CÓDIGO EMB.
PL0676.41.42 10



CÓDIGO EMB.
PL0676.41.43 10



Vista parte traseira

Com conector e haste



CÓDIGO EMB.
PL0676.19.41 10



CÓDIGO EMB.
PL0676.19.42 10



CÓDIGO EMB.
PL0676.19.43 10



Vista parte traseira

REPOSIÇÃO

Chicote universal
Com conector
ultra seal 2 vias

CÓDIGO EMB.
PL9946.17.00 10



Chicote universal
Com conector
ultra seal 2 vias e
conector Faston

CÓDIGO EMB.
PL9946.41.00 10



Haste
Para lanternas
tipo Facchini
e universal

REPOSIÇÃO EMB.
PL0606.19.17 10



PL 0206

Lanterna delimitadora LED



CÓDIGO TENSÃO EMB.
PL0206.12.41 LED 12V 10
IL5092
PL0206.24.41 LED 24V 10
IL5096



CÓDIGO TENSÃO EMB.
PL0206.12.42 LED 12V 10
IL5093
PL0206.24.42 LED 24V 10
IL5097



CÓDIGO TENSÃO EMB.
PL0206.12.43 LED 12V 10
IL5094
PL0206.24.43 LED 24V 10
IL5098



CÓDIGO TENSÃO EMB.
PL0206.12.51 LED 12V 10
PL0206.24.51 LED 24V 10



CÓDIGO TENSÃO EMB.
PL0206.12.52 LED 12V 10
IL5095
PL0206.24.52 LED 24V 10
IL5099

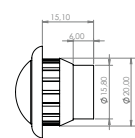
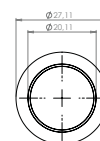

PL 0902

Lanterna universal tipo Mercosul
Com lente em acrílico
Para lâmpada esmagada

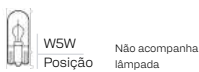

Com LED **LED BIVOLT**



REPOSIÇÃO

Lente para lanterna universal tipo Mercosul
Com lente em acrílico



PL 0904

Lanterna universal tipo Mercosul
Com lente em acrílico

LED BIVOLT



Com haste



REPOSIÇÃO

Lente para lanterna PL0904 LED
Com lente em acrílico



Haste
Para lanternas tipo Facchini e universal

PL 0606

Lanterna lateral refletiva
Aplicação Facchini
Com conector



Base reta e com **LED BIVOLT**



Para lâmpada tipo torpedo



Com haste



REPOSIÇÃO

Lente refletiva para lanterna



Haste
Para lanternas tipo Facchini e universal



Chicote 2 vias

PL 0608

Lanterna lateral com refletivo
Base Retã - Aplicação Facchini e universal



LED BIVOLT



Com haste

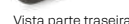

REPOSIÇÃO

Haste
Para lanternas tipo Facchini e universal



PL 0310

Lanterna luz de placa

LED BIVOLT

Com 3 LED's

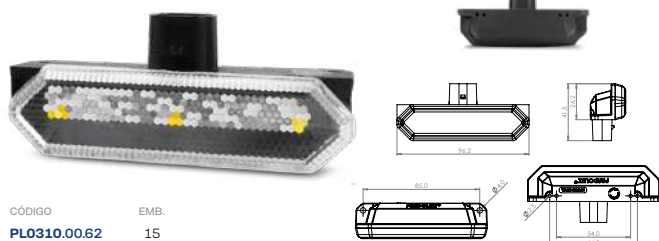

CÓDIGO EMB.
PL0310.00.62 15

PL 0544

Lanterna luz de placa

LED BIVOLT

Com 2 LED's

Para lâmpada T4W (69)
Posição Não acompanha lâmpada



CÓDIGO EMB.
PL0544.00.57 15

CÓDIGO EMB.
PL0544.00.17 15

PL 1322

Lanterna LED delimitadora e luz de placa

Aplicação ônibus Neobus e Induscar

Com lente em acrílico e 2 LED's

Com cabos para conexão



LED BIVOLT



CÓDIGO EMB.
PL1322.00.62 10

CÓDIGO EMB.
PL1322.00.61 10

CÓDIGO EMB.
PL1322.00.63 10

Com conector



CÓDIGO EMB.
PL1322.41.62 10

CÓDIGO EMB.
PL1322.41.61 10

CÓDIGO EMB.
PL1322.41.63 10

PL 1334

Lanterna LED delimitadora e luz de placa

Com lente em acrílico e 2 LED's

Com cabos para conexão



LED BIVOLT



CÓDIGO EMB.
PL1334.00.62 10

CÓDIGO EMB.
PL1334.00.61 10

Para ABS de carretas



CÓDIGO EMB.
PL1334.00.63 10

CÓDIGO EMB.
PL1334.00.52 10

REF. ORIGINAL 4461055232

Com conector



CÓDIGO EMB.
PL1334.41.62 10

CÓDIGO EMB.
PL1334.41.61 10

Para ABS de carretas



CÓDIGO EMB.
PL1334.41.63 10

CÓDIGO EMB.
PL1334.41.52 10

PL 0480

Lanterna luz de placa universal

Com LED LED BIVOLT



CÓDIGO EMB.
PL0480.00.56 10

CÓDIGO EMB.
PL0480.00.41 10

CÓDIGO EMB.
PL0480.00.42 10

CÓDIGO EMB.
PL0480.00.43 10

Para lâmpada T4W (69)
Posição Não acompanha lâmpada



CÓDIGO EMB.
PL0480.00.16 10

CÓDIGO EMB.
PL0480.00.01 10

CÓDIGO EMB.
PL0480.00.02 10

CÓDIGO EMB.
PL0480.00.03 10

REPOSIÇÃO

Lente para lanterna



CÓDIGO EMB.
PL0481.00.16 10

CÓDIGO EMB.
PL0481.00.01 10



CÓDIGO EMB.
PL0481.00.02 10

CÓDIGO EMB.
PL0481.00.03 10

FORD CARGO 2422



Soquete disponível



Soquete disponível



Soquete disponível



FORD CARGO 2429



Soquete disponível



Soquete disponível



Chicote disponível



Chicote disponível



FORD CARGO 815



Soquete disponível



Soquete disponível



Soquete disponível



FORD CARGO 1317



Soquete disponível



Soquete disponível



Soquete disponível



FORD CARGO 816/1119

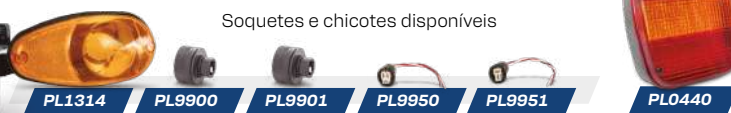

FORD CARGO 2628 TRAÇADO

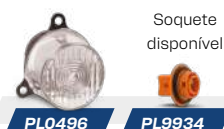
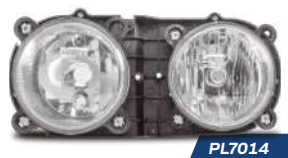

PL 7010

Farol duplo horizontal com soquete amarelo
Aplicação caminhões Ford Cargo 2000 a 2006



Não acompanha lâmpada

PL 7012

Farol duplo diagonal com soquete amarelo
Aplicação caminhões Ford Cargo 2000 a 2006



Não acompanha lâmpada

REPOSIÇÃO

Módulo óptico luz alta

Aplicação caminhões Ford Cargo 2000 a 2006



CÓDIGO EMB.
PL7011.00.22 01

Módulo óptico luz baixa

Aplicação caminhões Ford Cargo 2000 a 2006



CÓDIGO EMB.
PL7013.00.22 01

CÓDIGO	LADO	REF. ORIGINAL	EMB.
PL7010.01.22	Direito	1C45-13005-SCA	01
PL7010.02.22	Esquerdo	1C45-13006-SCA	01

CÓDIGO	LADO	REF. ORIGINAL	EMB.
PL7012.01.22	Direito	1C45-13005-SBA	01
PL7012.02.22	Esquerdo	1C45-13006-SBA	01

PL 7014

Farol duplo horizontal com soquete azul
Aplicação caminhões Ford Cargo 2006 a 2012



Vista parte traseira

CÓDIGO	LADO	EMB.	H7 Farol
PL7014.01.22	Direito	01	Não acompanha lâmpada
PL7014.02.22	Esquerdo	01	

PL 7016

Farol duplo diagonal com soquete azul
Aplicação caminhões Ford Cargo 2006 a 2012



Vista parte traseira

CÓDIGO	LADO	EMB.	H7 Farol
PL7016.01.22	Direito	01	Não acompanha lâmpada
PL7016.02.22	Esquerdo	01	

REPOSIÇÃO

Módulo óptico luz alta

Aplicação caminhões Ford Cargo 2006 a 2012



CÓDIGO	EMB.
PL7007.00.22	01

Módulo óptico luz baixa

Aplicação caminhões Ford Cargo 2006 a 2012



CÓDIGO	EMB.
PL7009.00.22	01

Soquete 2 polos para faróis Ford Cargo



CÓDIGO	EMB.
PL9974.37.97	10

PL 7006

Farol principal de luz alta
Aplicação caminhões Ford Cargo a partir de 2012



Vista parte traseira



H7
Farol
Não acompanha lâmpada

CÓDIGO	LADO	REF. ORIGINAL	EMB.
PL7006.01.22	Direito	BC4513D118AC	01
PL7006.02.22	Esquerdo	BC4513D119AC	01

REPOSIÇÃO

Módulo óptico luz alta

Aplicação caminhões Ford Cargo



CÓDIGO	EMB.
PL7007.00.22	01

PL 7008

Farol de luz baixa
Aplicação caminhões Ford Cargo a partir de 2012



Vista parte traseira



H7
Farol
Não acompanha lâmpada

CÓDIGO	LADO	REF. ORIGINAL	EMB.
PL7008.01.22	Direito	BC4513D268AE	01
PL7008.02.22	Esquerdo	BC4513D269AE	01

REPOSIÇÃO

Módulo óptico luz baixa

Aplicação caminhões Ford Cargo



CÓDIGO	EMB.
PL7009.00.22	01

PL 7064

Farol principal
Aplicação caminhões Ford Cargo 816 / 1119 de 2012 até 2016



H4
Farol
Não acompanha lâmpada

CÓDIGO	LADO	EMB.
PL7064.01.22	Direito	01
PL7064.02.22	Esquerdo	01

REPOSIÇÃO

Módulo óptico para farol principal

Aplicação caminhões Ford Cargo 816 / 1119 de 2014 até 2019



REPOSIÇÃO	LADO	REF. ORIGINAL	EMB.
PL7023.01.22	Direito	EC45 13005	01
PL7023.02.22	Esquerdo	EC45 13006	01

PL 1314

Lanterna direcional e posição
Com lente em acrílico
Aplicação Ford 1119 e 816 e ô nibus



Sem soquete

CÓDIGO	REF. ORIGINAL	EMB.
PL1314.00.21	EC45 13B376 AD (Direito) EC45 13B377 AD (Esquerdo)	10



Vista parte lateral



P21W (1141)
Direcional

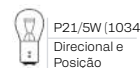

P21/5W (1034)
Direcional e Posição
Não acompanha lâmpada

REPOSIÇÃO

Soquete com 1 polo



REPOSIÇÃO	EMB.
PL9900.17.94	10

Soquete com 2 polos



REPOSIÇÃO	EMB.
PL9901.37.94	10

Chicote 2 vias



REPOSIÇÃO	EMB.
PL9950.17.00	10

Chicote 3 vias



REPOSIÇÃO	EMB.
PL9951.37.00	10

PL 0464

Lanterna direcional
Aplicação Ford Cargo 1720 e outros

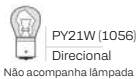

CÓDIGO	COR	REF. ORIGINAL	EMB.
PL0464.00.01	Amarelo	90HU13368B	04
PL0464.00.02	Cristal	-	04
PL0464.00.13	Amarelo fosca	-	04

PL 0460

Lanterna direcional
Aplicação caminhões Ford

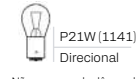

CÓDIGO	LADO	REF. ORIGINAL	EMB.	CÓDIGO	LADO	EMB.
PL0460.01.02	Direito	7295 3046 D	04	PL0460.21.02	Direito	04
PL0460.02.02	Esquerdo	7295 3045 E	04	PL0460.22.02	Esquerdo	04

PL 0434

Lanterna direcional
Aplicação Ford Cargo

Lente lisa

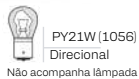

CÓDIGO	LENTE	LADO	EMB.
PL0434.23.02	-	Direito	10
PL0434.24.02	-	Esquerdo	10
PL0434.23.22	Acrílica	Direito	10
PL0434.24.22	Acrílica	Esquerdo	10

Com cúpula

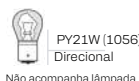

CÓDIGO	LADO	REF. ORIGINAL	EMB.
PL0434.03.02	Direito	2UH953042	10
PL0434.04.02	Esquerdo	2UH953041	10

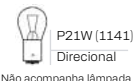

CÓDIGO	LADO	REF. ORIGINAL	EMB.
PL0434.01.01	Direito	86HU13369AA	10
PL0434.02.01	Esquerdo	86HU13368AA	10

REPOSIÇÃO

Chicote com soquete 1 polo tipo cachimbo e terminal



REPOSIÇÃO	EMB.
PL9936.17.94	10

PL 0494

Lanterna direcional
Com lente em policarbonato
Aplicação Ford Cargo traçado frente horizontal

Com soquete

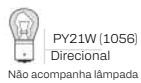

CÓDIGO	EMB.
PL0494.00.22	06

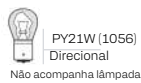
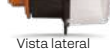

CÓDIGO	REF. ORIGINAL	EMB.
PL0494.41.22	4C46/13368/CA	06

PL 0496

Lanterna direcional
Com lente em policarbonato
Aplicação Ford Cargo frente diagonal

Com soquete

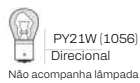

CÓDIGO	EMB.
PL0496.00.22	06

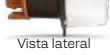

CÓDIGO	REF. ORIGINAL	EMB.
PL0496.41.22	4C46/13368/BA	06

REPOSIÇÃO

Soquete com 1 polo em nylon



REPOSIÇÃO	EMB.
PL9934.17.95	10

PL 0406

Lanterna delimitadora com pedestal
Aplicação Ford e universal

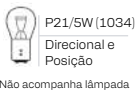

CÓDIGO	DESCRIÇÃO	EMB.
PL0406.37.05	Com 2 polos	10
PL0406.00.05	Com 1 polo para tratores	10

PL 0474

Lanterna direcional e delimitadora
Aplicação Ford Cargo (2012 em diante)

LED 24V



Com conector tipo original

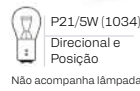

CÓDIGO	LADO	REF. ORIGINAL	EMB.
PL0474.01.21	Direito	AC46/13B376/AB/	02
PL0474.02.21	Esquerdo	AC46/13B377/AB/	02



CÓDIGO	LADO	EMB.
PL0474.33.41	Direito	02
PL0474.34.41	Esquerdo	02

REPOSIÇÃO

Chicote com conector 3 polos



REPOSIÇÃO	EMB.
PL9995.37.97	10

PL 0270

Lanterna delimitadora com parafusos embutidos na base
Aplicação caminhões Ford / VW

LED BIVOLT



REPOSIÇÃO

Soquete com 1 polo



T4W (69) Posição Não acompanha lâmpada



REPOSIÇÃO EMB. PL9913 .1797 20

CÓDIGO	EMB.	CÓDIGO	REF. ORIGINAL	EMB.	REPOSIÇÃO	EMB.
PL0270.00.42	10	PL0270.00.02	2R2 945 341 A1	20	PL9913	.1797 20

PL 0470

Conjunto óptico para lanternas delimitadoras PL0442 e PL0462

LED BIVOLT



REPOSIÇÃO

Soquete com 1 polo



REPOSIÇÃO EMB. PL9913.1797 20

CÓDIGO	EMB.
PL0470.00.42	05

Com soquete



T4W (69) Posição Não acompanha lâmpada

CÓDIGO	REF. ORIGINAL	EMB.
PL0470.00.02	154.4287 TU	20



T4W (69) Posição Não acompanha lâmpada

CÓDIGO	REF. ORIGINAL	EMB.
PL0470.41.02	2R2945341A1	20

PL 0462

Lanterna delimitadora
Aplicação Ford Cargo

Aplicação Ford Cargo Novo cabine simples

Com soquete

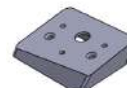

T4W (69) Posição Não acompanha lâmpada

Com fios

LED BIVOLT



CÓDIGO	LADO	REF. ORIGINAL	EMB.	CÓDIGO	LADO	EMB.
PL0462.01.02	Direito	7C46 15K 490 BA	10	PL0462.01.42	Direito	10
PL0462.02.02	Esquerdo	7C46 15K 491 BA	10	PL0462.02.42	Esquerdo	10

Aplicação Ford Cargo antigo

Com soquete



T4W (69) Posição Não acompanha lâmpada

Com fios

LED BIVOLT



CÓDIGO	DESCRIÇÃO	EMB.	CÓDIGO	DESCRIÇÃO	EMB.
PL0462.15.02	base reta	10	PL0462.15.42	base reta	10

Aplicação Ford 2004 e universal

Com soquete



T4W (69) Posição Não acompanha lâmpada

Aplicação Ford Cargo cabine estendida e teto alto.

Com soquete



T4W (69) Posição Não acompanha lâmpada

CÓDIGO	LADO	EMB.	CÓDIGO	LADO	REF. ORIGINAL	EMB.
PL0462.21.02	Direito	10	PL0462.35.02	Direito	3C46 15K 490 AA	10
PL0462.22.02	Esquerdo	10	PL0462.36.02	Esquerdo	3C46 15K 491 AA	10

PL 0426

Lanterna delimitadora
Aplicação Ford Cargo e MB 14 / 16 / 18



LED BIVOLT



LED BIVOLT

sem soquete



T4W (69) Posição Não acompanha lâmpada

Com soquete



T4W (69) Posição Não acompanha lâmpada

Furos para encaixe em caminhões Ford e MB

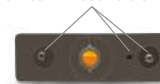

Vista parte traseira

REPOSIÇÃO

Soquete com 1 polo



CÓDIGO	TENSÃO	COR	EMB.	CÓDIGO	COR	EMB.
PL0426.21.41	LED BIVOLT	Amarelo	20	PL0426.21.01	Amarelo	20
PL0426.21.42	LED BIVOLT	Cristal	20	PL0426.21.02	Cristal	20

CÓDIGO	COR	REF. ORIGINAL	EMB.
PL0426.31.01	Amarelo	384 820 70 56	20
PL0426.31.02	Cristal	-	20

REPOSIÇÃO EMB. PL9913.1797 20

PL 0440 LED

Lanterna traseira LED para caminhões Ford / VW



LED BIVOLT

CÓDIGO	DESCRIÇÃO	LADO	EMB.
PL0440.21.49	22 LEDs - Sem vigia	Direito	06
PL0440.22.49	24 LEDs - Com vigia	Esquerdo	06

Com lente lisa



LED BIVOLT

CÓDIGO	DESCRIÇÃO	LADO	EMB.
PL0440.23.49	22 LEDs - Sem vigia	Direito	06
PL0440.24.49	24 LEDs - Com vigia	Esquerdo	06

PL 0440

Lanterna traseira

para caminhões Ford / VW (VW de 89 a 2011)



Com lente lisa



Com lente bicolor



CÓDIGO	DESCRIÇÃO	LADO	EMB.
PL0440.01.09	Sem vigia	Direito	06

REF. ORIGINAL Ford 98HU13404AA - VW T12 945 096

CÓDIGO	DESCRIÇÃO	LADO	EMB.
PL0440.02.09	Com vigia	Esquerdo	06

REF. ORIGINAL Ford 98HU13405AA - VW T12 945 095



CÓDIGO	DESCRIÇÃO	LADO	EMB.
PL0440.23.09	Sem vigia	Direito	06
PL0440.24.09	Com vigia	Esquerdo	06



CÓDIGO	DESCRIÇÃO	LADO	EMB.
PL0440.01.07	Sem vigia	Direito	06
PL0440.02.07	Com vigia	Esquerdo	06



REPOSIÇÃO

Lente tricolor



REPOSIÇÃO	EMB.
PL0441.00.09	30

REF. ORIGINAL
T12 945 223 A

REPOSIÇÃO

Lente lisa



REPOSIÇÃO	EMB.
PL0441.23.09	30

REPOSIÇÃO

Lente bicolor



REPOSIÇÃO	EMB.
PL0441.00.07	30

PL 0716

Lanterna traseira

Aplicação Ford / MB

Com lente com borda reforçada

LED 12V



Com conector 5 vias e lente com borda reforçada

LED 12V



REPOSIÇÃO

Lente refletiva com borda reforçada



CÓDIGO	EMB.
PL0717.33.09	15

CÓDIGO	DESCRIÇÃO	LADO	EMB.
PL0716.21.49	24 LEDs - Sem vigia	Direito	01
PL0716.22.49	26 LEDs - Com vigia	Esquerdo	01

CÓDIGO	DESCRIÇÃO	LADO	EMB.
PL0716.41.49	24 LEDs - Sem vigia	Direito	01
PL0716.42.49	26 LEDs - Com vigia	Esquerdo	01

Com fios para conexão



Com conector 5 vias e lente acrílica



Lente refletiva



CÓDIGO	EMB.
PL0717.00.09	15



CÓDIGO	DESCRIÇÃO	LADO	REF. ORIGINAL	EMB.
PL0716.01.09	Sem vigia	Direito	688 544 72 03	05
PL0716.02.09	Com vigia	Esquerdo	688 544 71 03	05

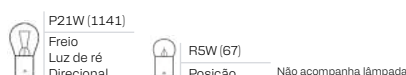

CÓDIGO	DESCRIÇÃO	LADO	REF. ORIGINAL	EMB.
PL0716.41.29	Sem vigia	Direito	688 544 92 03 CC 4513 405 AB	04
PL0716.42.29	Com vigia	Esquerdo	688 544 91 03 CC 4513 404 AB	04

Chicote 5 vias fêmea



CÓDIGO	EMB.
PL9999.17.97	15

DAF XF



PL6046



PL6048



PL0694



PL0682



PL1620



PL9990

Chicote disponível

DAF XF



PL6052



PL6054



PL0632



PL0694



PL0692



PL1620



PL9990

Chicote disponível

PL 6046

Farol principal

Aplicação caminhões DAF XF/CF a partir 2020



Conector tipo original



H1
Farol



H7
Farol



PY21W (1056)
Direcional

Não acompanha lâmpada

CÓDIGO	LADO	REF. ORIGINAL	EMB.
PL6046.01.02	Direito	1835879/875	01
PL6046.02.02	Esquerdo	1835878/874	01

PL 6048

Farol auxiliar

Aplicação caminhões DAF XF/CF a partir 2020



Conector tipo original



H11
Farol

Não acompanha lâmpada

CÓDIGO	LADO	REF. ORIGINAL	EMB.
PL6048.01.02	Direito	1835887	01
PL6048.02.02	Esquerdo	1835886	01

PL 6052

Farol principal

Aplicação caminhões DAF XF 2010 a 2019



Conector tipo original



H1
Farol



H7
Farol



P21W (1141)
Direcional



WSW
Posição

Não acompanha lâmpada

CÓDIGO	LADO	REF. ORIGINAL	EMB.
PL6052.01.02	Direito	1641743 1699301 1743685	01
PL6052.02.02	Esquerdo	1641742 1699300 1743684	01

PL 6054

Farol auxiliar

Aplicação caminhões DAF CF



Vista traseira



H3
Farol

Não acompanha lâmpada

CÓDIGO	LADO	REF. ORIGINAL	EMB.
PL6054.01.02	Direito	1725271	01
PL6054.02.02	Esquerdo	1725270	01

PL 0632

Lanterna delimitadora LED
Com lente em acrílico
Aplicação DAF XF e CF

LED 24V



CÓDIGO	EMB.
PL0632.00.42	04

PL 0682

Lanterna delimitadora
Aplicação DAF XF



CÓDIGO	LADO	REF. ORIGINAL	EMB.
PL0682.01.22	Direito	1846492	01
PL0682.02.22	Esquerdo	1846491	01

PL 0692

Lanterna direcional
Com lente em acrílico
Aplicação DAF XF



CÓDIGO	REF. ORIGINAL	EMB.
PL0692.41.21	1815754	4

Não acompanha lâmpada

PL 0694

Lanterna de posição lateral LED
Com lente em acrílico
Aplicação DAF XF

LED 24V



CÓDIGO	REF. ORIGINAL	EMB.
PL0694.41.61	1862083	10

PL 1620

Lanterna traseira
Com conector e lente em acrílico
Aplicação DAF XF



Não acompanha lâmpada

CÓDIGO	DESCRIÇÃO	LADO	REF. ORIGINAL	EMB.
PL1620.41.27	Sem vigia	Direito	1875578	01
PL1620.42.27	Com vigia	Esquerdo	1875577	01

REPOSIÇÃO

Chicote com conector 8 vias



REPOSIÇÃO	EMB.
PL9990.00.97	10

Lente Acrílica



REPOSIÇÃO	LADO	EMB.
PL1621.01.27	Direito	02
PL1621.02.27	Esquerdo	02

PL 0306

Lanterna direcional
Aplicação Chevrolet (até 88)



CÓDIGO	DESCRIÇÃO	EMB.
PL0306.86.02	Com 2 polos	4
PL0306.85.02	Com 1 polo	4



CÓDIGO	DESCRIÇÃO	REF. ORIGINAL	EMB.
PL0306.83.02	Com 2 polos	73 175 75	4



Vista traseira
2 polos

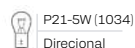

Não acompanha lâmpada



Vista traseira
1 polo

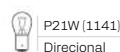

Não acompanha lâmpada

PL 0420

Lanterna direcional
Aplicação caminhões GM

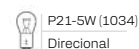

Não acompanha lâmpada

CÓDIGO	REF. ORIGINAL	EMB.
PL0420.00.01	94 630 600	5

REPOSIÇÃO

Lente para lanterna



REPOSIÇÃO	EMB.
PL0409.00.01	20

CAMINHÕES HYUNDAI

PL 0826

Lanterna traseira
Com lente em acrílico
Aplicação caminhões Hyundai HR

Com conector e tampa
de proteção tipo original



Vista parte traseira

CÓDIGO	DESCRIÇÃO	LADO	REF. ORIGINAL	EMB.
PL0826.01.29	Sem chicote	Direito	924024F000	01
PL0826.02.29	Sem chicote	Esquerdo	924014F000	01
PL0826.41.29	Com chicote	Direito	-	01
PL0826.42.29	Com chicote	Esquerdo	-	01

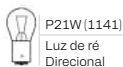

P21W (1141)
Luz de ré
Direcional



P21/5W (1034)
Freio e Posição
Não acompanha lâmpada

REPOSIÇÃO Chicote completo



REPOSIÇÃO EMB.
PL9952.41.00 10



CAMINHÕES KIA

PL 0828

Lanterna traseira
Aplicação Kia Bongo K2500 / K2700



Vista traseira



Vista traseira
com chicote

CÓDIGO	DESCRIÇÃO	REF. ORIGINAL	EMB.
PL0828.00.27	Sem chicote	-	01
PL0828.49.27	Com chicote	924014E020	01



PY21W (1056)
Direcional

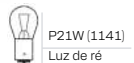

P21W (1141)
Luz de ré

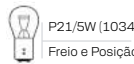

P21/5W (1034)
Freio e Posição
Não acompanha lâmpada

REPOSIÇÃO Chicote completo



REPOSIÇÃO EMB.
PL9991.41.00 10



CAMINHÕES RENAULT

PL 0830

Lanterna traseira
com conector tipo original
Aplicação Renault Master Carga



Vista traseira



REPOSIÇÃO Lente PL0830

Lente PL0830



CÓDIGO	DESCRIÇÃO	LADO	EMB.
PL0830.01.29	Sem vigia	Direito	01
PL0830.02.29	Com vigia	Esquerdo	01

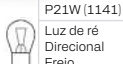

P21W (1141)
Luz de ré
Direcional
Freio
Neblina

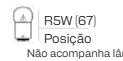

R5W (67)
Posição
Não acompanha lâmpada

REPOSIÇÃO EMB.
PL0831.00.29 01



CAMINHÕES IV

IV STRALIS HD



Soquete disponível



Soquete disponível



IV STRALIS



Soquete disponível



Soquete disponível



IV CURSOR



Soquete disponível



Soquete disponível



IV TECTOR



Soquete disponível



Soquete disponível



CAMINHÕES IV

IV HI-WAY



PL6024



PL0732



Soquete disponível
PL9918



PL0734



PL0742



PL0748



PL1527



PL0720

IV VERTIS



PL0730



Soquete disponível
PL9928



PL0736

IV EUROTECH



PL0730



Soquete disponível
PL9928



PL0722



Soquete disponível
PL9918

PL 6024

Farol principal

Com conector tipo original
Aplicação caminhões Stralis a partir de 2010



CÓDIGO	LADO	REF. ORIGINAL	EMB.
PL6024.01.02	Direito	504238093	01
PL6024.02.02	Esquerdo	504238117	01

CÓDIGO	LADO	EMB.
PL6024.21.02	Direito	01
PL6024.22.02	Esquerdo	01



Vista parte traseira



H7
Farol



WSW
Posição

Não acompanha lâmpada

REPOSIÇÃO

Kit com presilhas de aço



CÓDIGO	EMB.
PL6024.00.00	10

Lente em plicarbonato para farol



CÓDIGO	LADO	EMB.
PL6025.00.22	Bilateral	01

PL 0734

Lanterna direcional
Com lente em acrílico
Aplicação IV Stralis



CÓDIGO	LADO	REF. ORIGINAL	EMB.	CÓDIGO	LADO	EMB.
PL0734.01.21	Direito	41221039 / 504250984	02	PL0734.01.22	Direito	02
PL0734.02.21	Esquerdo	41221029 / 504250958	02	PL0734.02.22	Esquerdo	02

PL 0722

Lanterna direcional
Com lente em acrílico
Aplicação IV Eurotech



CÓDIGO	LADO	REF. ORIGINAL	EMB.	REPOSIÇÃO	EMB.
PL0722.01.22	Direito	984 636 D	02	PL9918.1796	10
PL0722.02.22	Esquerdo	984 638 E	02		

PL 0860

Lanterna direcional LED
Com lente em acrílico e conector tipo original
Aplicação IV S-Way



CÓDIGO	LADO	REF. ORIGINAL	EMB.
PL0860.41.41	Direito	5802320539	02
PL0860.42.41	Esquerdo	5802320542	02

PL 0754

Lanterna direcional
Com lente em acrílico
Com soquete
Aplicação IV Tector e Cursor a partir de 2025



CÓDIGO	LADO	REF. ORIGINAL	EMB.
PL0754.91.41	Direito	5803326574	02
PL0754.92.41	Esquerdo	5803326573	02

Aplicação IV Tector e Cursor até 2024



CÓDIGO	REF. ORIGINAL	EMB.
PL0754.41.21	5801573146	01

PL 0732

Lanterna direcional
Aplicação IV Stralis, Tector e Cursor



CÓDIGO	LADO	REF. ORIGINAL	EMB.	CÓDIGO	LADO	EMB.
PL0732.01.01	Direito	42555041	06	PL0732.01.02	Direito	06
PL0732.02.01	Esquerdo	42555042	06	PL0732.02.02	Esquerdo	06

PL 0738

Lanterna direcional
Com lente em acrílico
Aplicação IV Stralis HD e Trakker



CÓDIGO	LADO	REF. ORIGINAL	EMB.	REPOSIÇÃO	EMB.
PL0738.01.22	Direito	42555022	4	PL9918.1796	10
PL0738.02.22	Esquerdo	42555023	4		

PL 1527

Refletivo "olho de gato" 60mm
Lente em acrílico
Com parafuso



CÓDIGO	REF. ORIGINAL	EMB.	CÓDIGO	EMB.
PL1527.00.21	693 544 00 05	30	PL1527.00.23	30

Com furo central



CÓDIGO	EMB.	CÓDIGO	EMB.
PL1527.21.21	30	PL1527.21.23	30

PL 0648

Lanterna delimitadora
Com lente em acrílico
Aplicação caminhões IV Tector



CÓDIGO	LADO	REF. ORIGINAL	EMB.
PL0648.00.02	Bilateral	504055623 504045133	10

PL 0730

Lanterna delimitadora
Sem soquete
Aplicação caminhões IV Stralis e Tector



CÓDIGO	LADO	REF. ORIGINAL	EMB.
PL0730.01.02	Direito	504047265	10
PL0730.02.02	Esquerdo	504047264	10

REPOSIÇÃO

Soquete em nylon
tipo VW para posição



WSW
Posição



Não acompanha lâmpada

CÓDIGO	EMB.
PL9928.17.97	20

PL 0742

Lanterna delimitadora LED
Com lente em acrílico e com chicote
Aplicação IV Hi-Way

LED24V



CÓDIGO	REF. ORIGINAL	EMB.
PL0742.41.62	5801546522	01
PL0742.42.62	5801546548	01

REPOSIÇÃO

Chicote universal com conector ultra seal 2 vias



REPOSIÇÃO	EMB.
PL9946.17.00	10

PL 0748

Lanterna de posição lateral
Com soquete e lente em acrílico
Aplicação caminhões IV Stralis

Aplicação caminhões IV Hi-Way e S-Way



T4W (69)
Posição
Não acompanha lâmpada



Vista parte traseira

LED BIVOLT

CÓDIGO	REF. ORIGINAL	EMB.
PL0748.41.21	41200664	05

CÓDIGO	EMB.
PL0748.00.61	05

PL 0736

Lanterna traseira
Aplicação IV Pick-up Daily



P21W (1141)

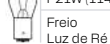

Freio
Luz de Ré

PY21W (1056)

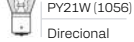

Direcional

RSW (67)



Posição

Não acompanha lâmpada

CÓDIGO	LADO	REF. ORIGINAL	EMB.
PL0736.41.07	Direito	69500026 ou 5801351224	01
PL0736.42.07	Esquerdo	69500032 ou 5801351218	01

Com conector tipo original
Sem vigia



Vista parte traseira

REPOSIÇÃO

Lente para lanterna traseira



CÓDIGO	REF. ORIGINAL	EMB.
PL0737.00.07	42555132	20

PL 1580

Lanterna traseira LED
Com conector tipo original e lente em acrílico
Aplicação IV S-Way

LED24V



Sem sirene de ré

CÓDIGO	DESCRIÇÃO	LADO	REF. ORIGINAL	EMB.
PL1580.01.67	Sem vigia	Direito	5802000767	01
PL1580.02.67	Com vigia	Esquerdo	5802240296	01

Com sirene de ré

CÓDIGO	DESCRIÇÃO	LADO	EMB.
PL1580.31.67	Sem vigia	Direito	01

Com conector tipo original



Vista parte traseira

REPOSIÇÃO

Lente para lanterna traseira



CÓDIGO	REF. ORIGINAL	EMB.
PL1581.00.27	1536401	20

Chicote com conector 8 vias



REPOSIÇÃO	EMB.
PL9990.00.97	10

PL 0720

Lanterna traseira
Aplicação IV

Com cabos para adaptação



CÓDIGO	DESCRIÇÃO	LADO	EMB.
PL0720.13.09	Sem vigia	Direito	03
PL0720.14.09	Com vigia	Esquerdo	03

Com conector tipo original



CÓDIGO	DESCRIÇÃO	LADO	REF. ORIGINAL	EMB.
PL0720.41.09	Sem vigia	Direito	994 63243	03
PL0720.42.09	Com vigia	Esquerdo	994 63242	03

P21W (1141)

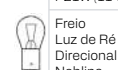

Freio
Luz de Ré

Direcional
Neblina

RSW (67)

Posição

Não acompanha lâmpada

REPOSIÇÃO

Lente para lanterna



CÓDIGO	EMB.
PL0721.00.09	15

REF. ORIGINAL 931 61844

MB ACTROS 2020



MB ACTROS 2015 ATÉ 2019



MB ACTROS ATÉ 2015



MB AXOR



MB ATEGO 2023...



MB ATEGO 2013 ATÉ 2022



MB ATEGO 2006 ATÉ 2012



MB ACELLO



MB ATRON 1719/2729



Soquetes disponíveis



Chicote disponível



Chicote disponível



MB ATRON 1319/1635/2324

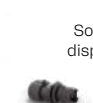

Soquetes disponíveis



Chicote disponível



MB 1938S-1944S



Chicote disponível



Chicote disponível



MB 1214 1721



Chicote disponível



MB 1933



PL7052



PL7058



PL0408



PL0594



PL0516



PL0500

MB 710-712-914



PL0528

Soquete disponível



PL9958



PL0450



PL0532



PL0716

Chicote disponível



PL9999

MB 1620



PL7002



PL0426



PL9913



PL0532



PL0448

Soquetes disponíveis



PL9924



PL9958

Chicote disponível



PL9996



PL0716

Chicote disponível



PL9999

MB 1935



PL0532



PL7050



PL7056

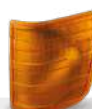

PL0448

Soquetes disponíveis



PL9924



PL9958

Chicote disponível



PL9996



PL0426



PL9913



PL0716

Chicote disponível



PL9999

PL 6006

Farol auxiliar com conector tipo original
Aplicação MB Axor



Com conector
tipo original

Vista parte traseira



H3
Farol
Não acompanha lâmpada

REPOSIÇÃO

Lente em vidro



CÓDIGO	LADO	REF. ORIGINAL	EMB.	REPOSIÇÃO	LADO	EMB.
PL6006.01.02	Direito	A9408200156	01	PL6007.01.02	Direito	01
PL6006.02.02	Esquerdo	A9408200056	01	PL6007.02.02	Esquerdo	01

PL 6036

Farol DRL LED
Com conector tipo original
Aplicação MB Actros

LED 24V



Vista parte traseira

REPOSIÇÃO

Chicote com conector
Aplicação MB para faróis PL6036



CÓDIGO	REF. ORIGINAL	EMB.	CÓDIGO	EMB.
PL6036.01.62	9608201056	01	PL9907.00.00	10
PL6036.02.62	9608200956	01		

PL 6030

Farol principal
Com conectores e soquetes tipo originais
Aplicação MB Axor



Vista parte traseira



H1
Farol
H7
Farol
Não acompanha lâmpada

CÓDIGO	LADO	REF. ORIGINAL	EMB.
PL6030.01.22	Direito	9408200261	01
PL6030.02.22	Esquerdo	9408200161	01

REPOSIÇÃO

Suporte superior



PL6031.00.17 01
REF. ORIGINAL 9408260113

Suporte inferior



PL6031.21.17 01
REF. ORIGINAL 9408260113

Moldura para farol



REPOSIÇÃO	LADO	EMB.
PL6031.01.16	Direito	04
REF. ORIGINAL 9408851022		
PL6031.02.16	Esquerdo	04
REF. ORIGINAL 9408850922		

Lente em policarbonato
para farol



REPOSIÇÃO	LADO	EMB.
PL6031.01.22	Direito	01
REF. ORIGINAL 0008264310		
PL6031.02.22	Esquerdo	01
REF. ORIGINAL 0008264210		

PL 6032

Farol principal
Com conectores e soquetes tipo originais
Aplicação MB Actros



Vista parte traseira

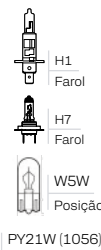

H1
Farol

H7
Farol

W5W
Posição



PY21W (1056)

Não acompanha lâmpada

CÓDIGO	LADO	REF. ORIGINAL	EMB.
PL6032.01.22	Direito	9438201561	01
PL6032.02.22	Esquerdo	9438201461	01

PL 6072

Farol principal com direcional e DRL
Aplicação MB Actros a partir de 2020



Vista parte traseira

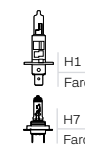

H1
Farol

H7
Farol



PY21W (1056)

Não acompanha lâmpada

CÓDIGO	LADO	COR	REF. ORIGINAL	EMB.
PL6072.01.02	Direito	Cristal	9618205139	01
PL6072.02.02	Esquerdo	Cristal	9618205039	01

PL 6056

Farol principal e auxiliar com lente lisa
Aplicação MB Atego 2006 até 2012



Vista parte traseira



H1
Farol



H7
Farol



W5W
Posição
Não acompanha lâmpada

CÓDIGO	LADO	REF. ORIGINAL	EMB.
PL6056.01.02	Direito	9738202861	01
PL6056.02.02	Esquerdo	9738202661	01



Vista parte traseira

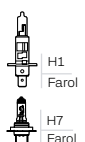

H1
Farol

H7
Farol

Não acompanha lâmpada

CÓDIGO	LADO	COR	REF. ORIGINAL	EMB.
PL6072.01.04	Direito	Fumê	9618206561	01
PL6072.02.04	Esquerdo	Fumê	9618206461	01

PL 6038

Farol auxiliar
Com conector e soquete tipo original
Aplicação MB Actros



Vista parte traseira

CÓDIGO	LADO	REF. ORIGINAL	EMB.
PL6038.01.22	Direito	9438200156	01
PL6038.02.22	Esquerdo	9438200056	01



PL 6070

Farol auxiliar de neblina
Aplicação MB Actros a partir de 2020



Vista parte traseira



CÓDIGO	LADO	REF. ORIGINAL	EMB.
PL6070.01.02	Direito	A9608200556	01
PL6070.02.02	Esquerdo	A9608200456	01



PL 7002

Farol duplo
Aplicação MB 1620 / 1218 / 1418
a partir de 2000



Vista parte traseira



CÓDIGO	LADO	REF. ORIGINAL	EMB.
PL7002.01.22	Direito	0160586 ou A6948200361	01
PL7002.02.22	Esquerdo	0160585 ou A6948200461	01

PL 7004

Farol duplo
Aplicação MB 1714 / 1618 / 1215 / 2428 /
2423 / 914 / 915



Vista parte traseira



CÓDIGO	LADO	REF. ORIGINAL	EMB.
PL7004.01.22	Direito	A6938200461	01
PL7004.02.22	Esquerdo	A6938200361	01

REPOSIÇÃO

Soquete 1 polo
para faróis MB / VW



CÓDIGO	EMB.
PL9976.17.97	10

Módulo óptico Farol



CÓDIGO	LADO	EMB.
PL7003.01.22	Direito	01
PL7003.02.22	Esquerdo	01

PL 7028

Farol duplo
Aplicação MB Atron de 2012 até 2021



Com lanterna direcional



Vista parte traseira



Vista parte traseira

CÓDIGO	LADO	REF. ORIGINAL	EMB.
PL7028.01.22	Direito	A696.820.02.61	01
PL7028.02.22	Esquerdo	A696.820.01.61	01



CÓDIGO	LADO	EMB.
PL7028.91.22	Direito	01
PL7028.92.22	Esquerdo	01



REPOSIÇÃO

Módulo óptico Farol luz alta



CÓDIGO	LADO	EMB.
PL7029.01.22	Direito	01
REF. ORIGINAL	789756350605 5	
CÓDIGO	LADO	EMB.
PL7029.02.22	Esquerdo	01
REF. ORIGINAL	789756350603 1	

Módulo óptico Farol luz baixa



CÓDIGO	LADO	EMB.
PL7033.01.22	Direito	01
REF. ORIGINAL	7897563506 0	
CÓDIGO	LADO	EMB.
PL7033.02.22	Esquerdo	01
REF. ORIGINAL	789756350604 8	

Lanterna direcional e delimitadora



CÓDIGO	LADO	EMB.
PL0348.03.22	Direito	01
PL0348.04.22	Esquerdo	01

Soquete em nylon tipo MB para farol luz alta



CÓDIGO	EMB.
PL9925.37.97	10

Soquete em nylon para posição



CÓDIGO	EMB.
PL9928.17.97	20

Soquete em nylon tipo MB para direcional



CÓDIGO	EMB.
PL9956.17.97	10

Chicote completo MB



CÓDIGO	EMB.
PL9987.41.00	10

PL 7060

Farol principal

Aplicação MB Atego a partir de 2013 até 2021



Vista parte traseira

CÓDIGO	LADO	EMB.
PL7060.01.22	Direito	01
PL7060.02.22	Esquerdo	01

Com lanterna direcional



Vista parte traseira

CÓDIGO	LADO	REF. ORIGINAL	EMB.
PL7060.91.22	Direito	9588201161	01
PL7060.92.22	Esquerdo	9588201061	01

Com lanterna direcional e máscara



Vista parte traseira

CÓDIGO	LADO	EMB.
PL7060.21.22	Direito	01
PL7060.22.22	Esquerdo	01



H1 Farol



H7 Farol



WSW Posição



PY21W (1056) Direcional

Não acompanha lâmpada

PL 7062

Farol principal

Com motor - regulagem automática
Aplicação MB Atego a partir de 2023



Vista parte traseira

CÓDIGO	LADO	EMB.
PL7062.01.22	Direito	01
PL7062.02.22	Esquerdo	01

Com lanterna direcional



Vista parte traseira

CÓDIGO	LADO	REF. ORIGINAL	EMB.
PL7062.91.22	Direito	9588201161	01
PL7062.92.22	Esquerdo	9588201061	01

Com lanterna direcional e máscara



Vista parte traseira

CÓDIGO	LADO	EMB.
PL7062.21.22	Direito	01
PL7062.22.22	Esquerdo	01



H1 Farol



H7 Farol



WSW Posição

Não acompanha lâmpada

REPOSIÇÃO

Módulo óptico Farol luz alta



CÓDIGO	LADO	REF. ORIGINAL	EMB.
PL7029.01.22	Direito	789756350605 5	01
PL7029.02.22	Esquerdo	789756350603 1	01

Módulo óptico Farol luz baixa



CÓDIGO	LADO	REF. ORIGINAL	EMB.
PL7033.01.22	Direito	7897563506 0	01
PL7033.02.22	Esquerdo	789756350604 8	01

Lanterna direcional



CÓDIGO	LADO	EMB.
PL0498.01.22	Direito	10
REF. ORIGINAL	958 820 01 21	
PL0498.02.22	Esquerdo	10
REF. ORIGINAL	958 820 02 21	

Lanterna direcional com DRL LED



CÓDIGO	LADO	EMB.
PL0870.33.42	Direito	10
PL0870.34.42	Esquerdo	10

Chicote completo MB



CÓDIGO	EMB.
PL9987.41.00	10

Máscara para farol PL7060

Aplicação MB Atego



Máscara para farol PL7062

Aplicação MB Atego



CÓDIGO	LADO	EMB.
PL7061.01.17	Direito	01
PL7061.02.17	Esquerdo	01

CÓDIGO	LADO	EMB.
PL7063.01.17	Direito	01
PL7063.02.17	Esquerdo	01

CÓDIGO	LADO	EMB.
PL7063.21.17	Direito	01
PL7063.22.17	Esquerdo	01

Soquete em nylon tipo MB para farol luz alta



CÓDIGO	EMB.
PL9925.37.97	10

Soquete em nylon tipo MB para direcional



CÓDIGO	EMB.
PL9956.17.97	10

Soquete em nylon para posição



CÓDIGO	EMB.
PL9928.17.97	20

PL 7030

Farol principal
Aplicação MB Actros
de 2016 até 2020



Com lanterna direcional

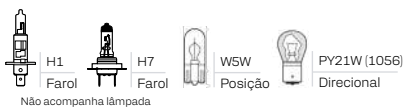

CÓDIGO	LADO	EMB.
PL7030.01.22	Direito	01
PL7030.02.22	Esquerdo	01

CÓDIGO	LADO	EMB.
PL7030.91.22	Direito	01
REF. ORIGINAL	9438206861	
PL7030.92.22	Esquerdo	01
REF. ORIGINAL	9438206761	

REPOSIÇÃO

Módulo óptico
Farol luz alta



CÓDIGO	LADO	EMB.
PL7031.01.22	Direito	01
REF. ORIGINAL	789756350605 5	
CÓDIGO <th>LADO</th> <th>EMB.</th>	LADO	EMB.
PL7031.02.22	Esquerdo	01
REF. ORIGINAL	789756350603 1	

Módulo óptico
Farol luz baixa



CÓDIGO	LADO	EMB.
PL7033.01.22	Direito	01
REF. ORIGINAL	7897563506 0	
CÓDIGO <th>LADO</th> <th>EMB.</th>	LADO	EMB.
PL7033.02.22	Esquerdo	01
REF. ORIGINAL	789756350604 8	

Lanterna direcional



CÓDIGO	LADO	EMB.
PL0498.01.22	Direito	10
REF. ORIGINAL	958 820 01 21	
PL0498.02.22	Esquerdo	10
REF. ORIGINAL	958 820 02 21	

Soquete em nylon
tipo MB para farol
luz alta



CÓDIGO	EMB.
PL9925.37.97	10

Soquete em nylon
tipo MB para
direcional



CÓDIGO	EMB.
PL9956.17.97	10

Soquete em nylon
para posição



CÓDIGO	EMB.
PL9928.17.97	20

Chicote completo MB



CÓDIGO	EMB.
PL9987.41.00	10

PL 7026

Farol duplo
Com adaptador para soquete cachimbo
Aplicação MB Accelo a partir de 2008

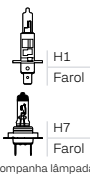

CÓDIGO	LADO	REF. ORIGINAL	EMB.
PL7026.01.22	Direito	A9798200461	01
PL7026.02.22	Esquerdo	A9798200361	01

REPOSIÇÃO

Módulo óptico
Farol luz baixa



CÓDIGO	EMB.
PL7009.00.22	01

Módulo óptico
Farol luz alta



CÓDIGO	LADO	EMB.
PL7027.01.22	Direito	01
PL7027.02.22	Esquerdo	01

PL 7054

Farol de neblina
Aplicação MB 1938 / 1620 / 1214 Accelo
e VW Constellation



CÓDIGO	REF. ORIGINAL	EMB.
PL7054.00.22	2T2941063	01

H3 Farol
Não acompanha lâmpada

PL 7050

Farol Principal Luz Baixa Com vigia
Aplicação MB 1214/1935

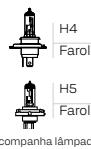

CÓDIGO	LADO	REF. ORIGINAL	EMB.
PL7050.01.22	Direito	384.820.8161	01
PL7050.02.22	Esquerdo	384.820.8161	01

PL 7056

Farol Principal Luz Alta Sem vigia
Aplicação MB 1214 até 2004

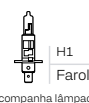

CÓDIGO	LADO	REF. ORIGINAL	EMB.
PL7056.00.22	Bilateral	3318208861	01

PL 7052

Farol Principal Luz baixa Com vigia
Aplicação MB 1113 / 1313 até 1992



Vista parte traseira



H4
Farol

CÓDIGO	LADO	REF. ORIGINAL	EMB.	
PL7052.01.22	Direito	331.820.8761	01	Não acompanha lâmpada
PL7052.02.22	Esquerdo	331.820.8961	01	

PL 7058

Farol Principal Luz Alta Sem vigia
Aplicação MB até 1990



Vista parte traseira



H1
Farol

CÓDIGO	LADO	REF. ORIGINAL	EMB.	
PL7058.00.22	Bilateral	3318209161	01	Não acompanha lâmpada

PL 0348

Lanterna direcional e posição lateral
Com lente em acrílico e sem soquete
Aplicação MB Atron



WSW
Posição

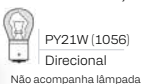

PY21W (1056)
Direcional
Não acompanha lâmpada

REPOSIÇÃO

Soquete em nylon
tipo MB para direcional



CÓDIGO	EMB.
PL9956.17.97	10

Soquete em nylon
para posição



CÓDIGO	EMB.
PL9928.17.97	20

CÓDIGO	LADO	REF. ORIGINAL	EMB.
PL0348.03.22	Direito	A 696 820 02 21	01
PL0348.04.22	Esquerdo	A 696 820 01 21	01

PL 0624

Lanterna direcional e posição
Com lente em acrílico
Aplicação MB Actros de 2021 a 2024

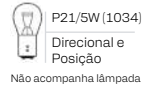

P21/SW (1034)
Direcional e
Posição
Não acompanha lâmpada

REPOSIÇÃO

Soquete com
2 polos



CÓDIGO	LADO	EMB.
PL0624.01.21	Direito	02
REF. ORIGINAL	9608201121 / 9608200421	
PL0624.02.21	Esquerdo	02
REF. ORIGINAL	9608201021 / 9608200421	

CÓDIGO	EMB.
PL9923.37.97	01

PL 0864

Lanterna direcional e posição
Com lente em acrílico
Aplicação MB Actros a partir de 2025



LED 24V

CÓDIGO	LADO	EMB.
PL0864.41.42	Direito	02
REF. ORIGINAL	9608201421	
PL0864.42.42	Esquerdo	02
REF. ORIGINAL	9608201521	

PL 0408

Lanterna direcional com 2 polos
Aplicação MB e universal

Base reta

Base curva
Com lente amarela e vermelha

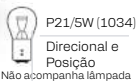

P21/SW (1034)
Direcional e
Posição
Não acompanha lâmpada

CÓDIGO	EMB.
PL0408.21.01	15
REF. ORIGINAL	331 822 70 20

CÓDIGO	EMB.
PL0408.35.05	15
PL0408.36.05	15

PL 0410

Lanterna direcional com 3 faces base reta
Aplicação MB e universal

Com lente amarela
e vermelha

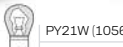

PY21W (1056)
Direcional

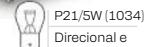

P21/SW (1034)
Direcional e
Posição
Não acompanha lâmpada

CÓDIGO	EMB.
PL0410.15.01	06
REF. ORIGINAL	350 820 70 05

CÓDIGO	EMB.
PL0410.15.02	06

CÓDIGO	EMB.
PL0410.15.05	06

REPOSIÇÃO

Lente para lanterna



CÓDIGO	EMB.
PL0409.00.01	20
REF. ORIGINAL	001 822 55 10



CÓDIGO	EMB.
PL0409.00.02	20

PL 0466

Lanterna direcional
Com lente em policarbonato
Aplicação MB 1938S e MB Axor
Sem soquete



CÓDIGO	EMB.	CÓDIGO	EMB.	CÓDIGO	EMB.
PL0466.00.21	05	PL0466.00.22	05	PL0466.41.21	05
REF. ORIGINAL	A 941 826 1021				



P21W (1141)
Direcional



PY21W (1056)
Direcional
Não acompanha lâmpada

PL 0476

Lanterna direcional
Com lente em acrílico
Aplicação MB Axor



Sem soquete

CÓDIGO	EMB.
PL0476.00.35	05
REF. ORIGINAL	A 940 820 0221

Com soquete

CÓDIGO	EMB.
PL0476.41.35	05

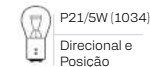

P21/SW (1034)
Direcional e
Posição



PY21W (1056)
Direcional
Não acompanha lâmpada

REPOSIÇÃO

Chicote com
soquete de
2 polos tipo
cachimbo



REPOSIÇÃO	EMB.
PL9917.37.94	10

PL 0498

Lanterna direcional
Aplicação MB Atego e Actros

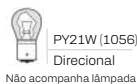

PY21W (1056)
Direcional
Não acompanha lâmpada

REPOSIÇÃO

Soquete em nylon tipo MB para direcional



CÓDIGO	LADO	REF. ORIGINAL	EMB.
PL0498.01.22	Direito	958 820 01 21	10
PL0498.02.22	Esquerdo	958 820 02 21	10

CÓDIGO	EMB.
PL9956.17.97	10

PL 0870

Lanterna direcional com DRL LED
Com luz de posição e direcional
Aplicação MB Atego a partir de 2024



LED24V

CÓDIGO	LADO	EMB.
PL0870.33.42	Direito	02
PL0870.34.42	Esquerdo	02

PL 0448

Lanterna direcional
Aplicação MB 14 / 16 / 18 (89 a 2011)



Não acompanha lâmpada

Sem vigia

CÓDIGO	LADO	REF. ORIGINAL	EMB.
PL0448.01.01	Direito	384 820 71 21	10
PL0448.02.01	Esquerdo	384 820 70 21	10

Com vigia

CÓDIGO	LADO	REF. ORIGINAL	EMB.
PL0448.45.01	Direito	694 820 70 21	10
PL0448.46.01	Esquerdo	694 820 71 21	10

Com lente lisa amarela



Não acompanha lâmpada

Sem vigia

CÓDIGO	LADO	EMB.
PL0448.23.01	Direito	10
PL0448.24.01	Esquerdo	10

Com vigia

CÓDIGO	LADO	EMB.
PL0448.25.01	Direito	10
PL0448.26.01	Esquerdo	10

Com lente lisa cristal

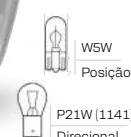

Não acompanha lâmpada

Sem vigia

CÓDIGO	LADO	EMB.
PL0448.23.02	Direito	10
PL0448.24.02	Esquerdo	10

Com vigia

CÓDIGO	LADO	EMB.
PL0448.25.02	Direito	10
PL0448.26.02	Esquerdo	10

Com lente lisa amarela



Não acompanha lâmpada

Sem vigia

CÓDIGO	LADO	EMB.
PL0448.03.02	Direito	10
PL0448.04.02	Esquerdo	10

Com vigia

CÓDIGO	LADO	EMB.
PL0448.05.02	Direito	10
PL0448.06.02	Esquerdo	10

Com lente fumê com cúpula



Não acompanha lâmpada

Sem vigia

CÓDIGO	LADO	EMB.
PL0448.03.04	Direito	10
PL0448.04.04	Esquerdo	10

Com vigia

CÓDIGO	LADO	REF. ORIGINAL	EMB.
PL0448.05.04	Direito	384 821 71 21	10
PL0448.06.04	Esquerdo	384 721 70 20	10

REPOSIÇÃO

Moldura em ABS com adesivo



Vista parte traseira

REPOSIÇÃO	LADO	EMB.
PL0448.07.14	Direito	10
PL0448.08.14	Esquerdo	10

Soquete em nylon tipo VW para posição



CÓDIGO	EMB.
PL9924.17.96	20

Soquete 1 polo em nylon tipo MB para direcional



CÓDIGO	EMB.
PL9958.17.00	10

Chicote com conector 2 vias para luz de posição



CÓDIGO	EMB.
PL9996.17.97	10

PL 0450

Lanterna direcional
Aplicação MB 718 / 912 / 914 e universal



Não acompanha lâmpada

CÓDIGO	REF. ORIGINAL	EMB.
PL0450.00.01	688 820 70 56	10



Não acompanha lâmpada

CÓDIGO	EMB.
PL0450.00.02	10

Lente para lanterna direcional



CÓDIGO	EMB.
PL0451.00.01	20

REF. ORIGINAL 000 820 00 56



CÓDIGO	EMB.
PL0451.00.02	20

PL 0518

Lanterna direcional
Aplicação MB 1718



CÓDIGO	LADO	EMB.
PL0518.01.01	Direito	08
REF. ORIGINAL 688 820 7621		

CÓDIGO	LADO	EMB.
PL0518.03.02	Direito	08
PL0518.04.02	Esquerdo	08

CÓDIGO	LADO	EMB.
PL0518.02.01	Esquerdo	08
REF. ORIGINAL 688 820 7621		

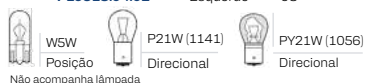

REPOSIÇÃO

Soquete em nylon tipo VW para posição



Soquete 1 polo em nylon tipo MB para direcional



Chicote com conector 2 vias para luz de posição



PL 0492

Lanterna delimitadora LED
com refletivo e conector tipo original
Aplicação MB Atego e Actros

LED 24V



CÓDIGO	REF. ORIGINAL	EMB.
PL0492.24.61	000 544 75 11	10

REPOSIÇÃO

Chicote com conector 2 vias para lanternas LED



PL 0528

Lanterna direcional sem soquete
Aplicação MB 708 / 709 / 710 / 712 / 912

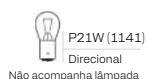

REPOSIÇÃO

Soquete 1 polo em nylon tipo MB para direcional



CÓDIGO	LADO	REF. ORIGINAL	EMB.
PL0528.01.01	Direito	688 820 71 21	10
PL0528.02.01	Esquerdo	688 820 70 21	10

CÓDIGO	LADO	EMB.
PL0528.01.02	Direito	10
PL0528.02.02	Esquerdo	10

PL 0548

Lanterna direcional
Aplicação MB 1214 / 1721 (89 a 96)

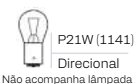

CÓDIGO	LADO	REF. ORIGINAL	EMB.
PL0548.01.01	Direito	682 820 71 21	05
PL0548.02.01	Esquerdo	682 820 70 21	05

PL 0520

Lanterna direcional sem soquete
Aplicação MB 1938S e 1944S

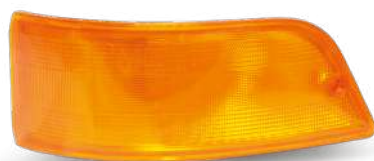

Com lente cristal e com cúpula

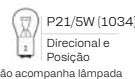

CÓDIGO	LADO	REF. ORIGINAL	EMB.
PL0520.01.01	Direito	A 940 820 0121 D	02
PL0520.02.01	Esquerdo	A 940 820 0021 E	02

CÓDIGO	LADO	EMB.
PL0520.03.02	Direito	02
PL0520.04.02	Esquerdo	02

REPOSIÇÃO

Chicote com soquete de 1 polo tipo cachimbo



Chicote com soquete de 2 polos tipo cachimbo



PL 0510

Lanterna direcional com base reta
Aplicação MB e universal

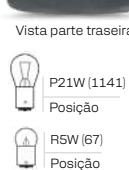

CÓDIGO	REF. ORIGINAL	EMB.
PL0510.15.01	308 822 01 20	30

CÓDIGO	EMB.
PL0510.15.02	30

PL 0594

Lanterna direcional com base reta
Aplicação MB (a partir de 84)



CÓDIGO	REF. ORIGINAL	EMB.
PL0594.00.01	331 826 71 47	10

CÓDIGO	REF. ORIGINAL	EMB.
PL0594.00.02	331 826 73 47	20

REPOSIÇÃO

Lente para lanterna



CÓDIGO	REF. ORIGINAL	EMB.
PL0511.00.01	98 000 822 86 10	25

CÓDIGO	EMB.
PL0511.00.02	25

REPOSIÇÃO

Lente para lanterna



CÓDIGO	REF. ORIGINAL	EMB.
PL0595.00.01	331 826 70 10	20

CÓDIGO	REF. ORIGINAL	EMB.
PL0595.00.02	331 826 72 10	20

PL 0514

Lanterna direcional
Aplicação MB 1113 e MB 1114



CÓDIGO	REF. ORIGINAL	EMB.	CÓDIGO	EMB.
PL0514.00.01	344 822 71 20	15	PL0514.00.02	15

P21W (1141)
Direcional
 PY21W (1056)
Direcional
Não acompanha lâmpada

REPOSIÇÃO

Lente para lanterna



CÓDIGO	REF. ORIGINAL	EMB.
PL0515.00.01	001 822 56 10	15



CÓDIGO	EMB.
PL0515.00.02	15

PL 0576

Lanterna direcional
Com lente em acrílico com conector
Aplicação MB Atego



CÓDIGO	LADO	EMB.	CÓDIGO	LADO	EMB.
PL0576.01.21	Direito	06	PL0576.01.22	Direito	06
REF. ORIGINAL 973 820 04 21			PL0576.02.22	Esquerdo	06
PL0576.02.21	Esquerdo	06			
REF. ORIGINAL 973 820 03 21					

P21W (1141)
Direcional
 PY21W (1056)
Direcional
Não acompanha lâmpada

REPOSIÇÃO

Lente para lanterna



CÓDIGO	LADO	EMB.	CÓDIGO	LADO	EMB.
PL0577.01.21	Direito	10	PL0577.01.22	Direito	10
PL0577.02.21	Esquerdo	10	PL0577.02.22	Esquerdo	10



CÓDIGO	LADO	EMB.
PL0577.01.22	Direito	10
PL0577.02.22	Esquerdo	10

Chicote com conector 2 vias

CÓDIGO	EMB.
PL9994.17.97	10

PL 0588

Lanterna direcional sem soquete
Aplicação MB Atego



CÓDIGO	LENTE	LADO	REF. ORIGINAL	EMB.
PL0588.01.02	PS	Direito	973 820 06 21	02
PL0588.02.02	PS	Esquerdo	973 820 05 21	02
PL0588.01.22	Acrílica	Direito	-	02
PL0588.02.22	Acrílica	Esquerdo	-	02

PY21W (1056)
Direcional
Não acompanha lâmpada

REPOSIÇÃO

Soquete em nylon tipo MB



CÓDIGO	EMB.
PL9922.17.96	10

PL 0612

Lanterna direcional e posição
Com lente em acrílico
Aplicação MB Actros

Com conector



CÓDIGO	REF. ORIGINAL	EMB.
PL0612.41.21	LD - 9418200521	02
	LE - 9418200921	

Sem conector



P21/SW (1034)
Direcional e Posição
Não acompanha lâmpada

CÓDIGO	EMB.
PL0612.60.21	02

REPOSIÇÃO

Chicote com conector e soquete 2 polos



REPOSIÇÃO	EMB.
PL9931.37.97	01

PL 0592

Lanterna direcional
Aplicação MB Axor

Sem soquete



Vista parte traseira

CÓDIGO	LADO	REF. ORIGINAL	EMB.
PL0592.01.02	Direito	940 820 04 21	04
PL0592.02.02	Esquerdo	940 820 03 21	04

Com soquete



Vista parte traseira

CÓDIGO	LADO	REF. ORIGINAL	EMB.
PL0592.41.02	Direito	940 820 04 21	04
PL0592.42.02	Esquerdo	940 820 03 21	04

PY21W (1056)
Direcional
Não acompanha lâmpada

REPOSIÇÃO

Soquete em nylon



CÓDIGO	EMB.
PL9922.17.96	10

PL 0574

Lanterna direcional
Com lente em acrílico
Aplicação MB Accelo

Sem soquetes



CÓDIGO	LADO	REF. ORIGINAL	EMB.
PL0574.01.22	Direito	A 979 820 0421 D	02
PL0574.02.22	Esquerdo	A 979 820 0321 E	02

Com soquetes



CÓDIGO	LADO	EMB.	CÓDIGO	LADO	EMB.
PL0574.41.22	Direito	02	PL0574.42.22	Esquerdo	02

P21/SW (1034)
Direcional e Posição
Não acompanha lâmpada
 PY21W (1056)
Direcional
 WSW
Posição

Soquete em nylon tipo VW para posição



CÓDIGO	EMB.
PL9924.17.96	20

Chicote com conector 2 vias para luz de posição



CÓDIGO	EMB.
PL9996.17.97	10

REPOSIÇÃO

Soquete 1 polo tipo VW



CÓDIGO	EMB.
PL9933.17.96	10

Soquete 2 polos tipo VW



CÓDIGO	EMB.
PL9935.37.96	10

PL 0426

Lanterna delimitadora
Aplicação Ford Cargo e MB 14 / 16 / 18



CÓDIGO	TENSÃO	COR	EMB.
PL0426.21.41	LED BIVOLT	Amarelo	20
PL0426.21.42	LED BIVOLT	Cristal	20

Sem soquete



CÓDIGO	COR	EMB.
PL0426.21.01	Amarelo	20
PL0426.21.02	Cristal	20

Com soquete



CÓDIGO	COR	REF. ORIGINAL	EMB.
PL0426.31.01	Amarelo	384 820 70 56	20
PL0426.31.02	Cristal	-	20

Furos para encaixe em caminhões Ford e MB

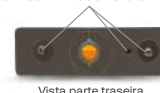

Vista parte traseira

REPOSIÇÃO

Soquete com 1 polo



REPOSIÇÃO	EMB.
PL9913.17.97	20

PL 0532

Lanterna delimitadora
Aplicação MB / 912



CÓDIGO	REF. ORIGINAL	EMB.
PL0532.00.07	688 820 78 56	10



Vista parte traseira



RSW (67) Posição

Não acompanha lâmpada

PL 0580

Lanterna delimitadora bilateral
Com lente em acrílico
Aplicação MB Atego, Accelo e Axor



CÓDIGO	REF. ORIGINAL	EMB.
PL0580.00.22	LD - 002 820 51 56	06
	LE - 002 820 50 56	

LED BIVOLT



RSW (67) Posição

Não acompanha lâmpada

PL 0428

Lanterna interna de cabine
Aplicação caminhões MB



CÓDIGO	REF. ORIGINAL	EMB.
PL0428.20.14	331 825 73 01	15



RSW (67) Posição

Não acompanha lâmpada

PL 1427

Refletivo traseiro
Com lente em acrílico
Aplicação ônibus, MB Accelo, Sprinter e universal



CÓDIGO	REF. ORIGINAL	EMB.
PL1427.00.21	A0 008 262 240	30

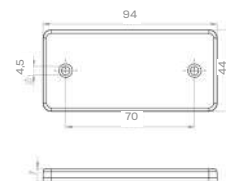

PL 0516

Lanterna traseira
Aplicação MB 1313 e universal



CÓDIGO	DESCRIÇÃO	LADO	EMB.
PL0516.01.05	Sem vigia	Direito	08
REF. ORIGINAL	344 544 71 03		
PL0516.02.05	Com vigia	Esquerdo	08
REF. ORIGINAL	344 544 70 03		



Vista lateral



RSW (67) Posição

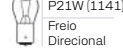

P21W (1141) Freio Direcional

Não acompanha lâmpada



CÓDIGO	DESCRIÇÃO	LADO	EMB.
PL0516.01.09	Sem vigia	Direito	08
PL0516.02.09	Com vigia	Esquerdo	08



RSW (67) Posição

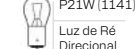

P21W (1141) Luz de Ré Direcional

Não acompanha lâmpada

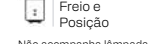

P21/SW (1034) Freio e Posição

Não acompanha lâmpada

REPOSIÇÃO

Lente vermelha e amarela



CÓDIGO	EMB.
PL0517.00.05	20
REF. ORIGINAL	008 544 00 90

Lente tricolor



CÓDIGO	EMB.
PL0517.00.09	20

PL 0500

Lanterna traseira
Aplicação MB 1113 (até 88)



CÓDIGO	DESCRIÇÃO	LADO	EMB.
PL0500.01.05	Sem vigia	Direito	12
REF. ORIGINAL	344 544 71 03		
PL0500.02.05	Com vigia	Esquerdo	12
REF. ORIGINAL	344 544 70 03		



RSW (67) Posição

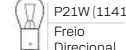

P21W (1141) Freio Direcional

Não acompanha lâmpada

REPOSIÇÃO

Lente para lanterna



CÓDIGO	EMB.
PL0501.00.05	15
REF. ORIGINAL	044 544 00 89

PL 0716 LED

Lanterna traseira LED
Aplicação Ford / MB

Com lente com borda reforçada e fios para conexão

LED BIVOLT



CÓDIGO	DESCRIÇÃO	LADO	EMB.
PL0716.21.49	24 LEDs - Sem vigia	Direito	01
PL0716.22.49	26 LEDs - Com vigia	Esquerdo	01

Com conector 5 vias e lente com borda reforçada

LED BIVOLT



CÓDIGO	DESCRIÇÃO	LADO	EMB.
PL0716.41.49	24 LEDs - Sem vigia	Direito	01
PL0716.42.49	26 LEDs - Com vigia	Esquerdo	01



Com conector
5 vias

REPOSIÇÃO

Lente refletiva com borda reforçada



REPOSIÇÃO	EMB.
PL0717.33.09	15

Chicote 5 vias fêmea



CÓDIGO	EMB.
PL9999.17.97	15

Com lente lisa e fios para conexão

LED BIVOLT



CÓDIGO	DESCRIÇÃO	LADO	EMB.
PL0716.23.49	24 LEDs - Sem vigia	Direito	01
PL0716.24.49	26 LEDs - Com vigia	Esquerdo	01

Com conector 7 vias e lente lisa

LED BIVOLT



CÓDIGO	DESCRIÇÃO	LADO	EMB.
PL0716.47.49	24 LEDs - Sem vigia	Direito	01
PL0716.48.49	26 LEDs - Com vigia	Esquerdo	01



Com conector
7 vias

REPOSIÇÃO

Lente lisa



CÓDIGO	EMB.
PL0717.23.09	15

Chicote 7 vias fêmea com 20cm de cabos



CÓDIGO	EMB.
PL9947.39.00	10

PL 0716

Lanterna traseira
para caminhões Ford / MB

Com fios para conexão



CÓDIGO	DESCRIÇÃO	LADO	REF. ORIGINAL	EMB.
PL0716.01.09	Sem vigia	Direito	688 544 72 03	05
PL0716.02.09	Com vigia	Esquerdo	688 544 71 03	05



P21W (1141)
Freio
Luz de ré
Direcional



RSW (67)
Posição
Não acompanha lâmpada

REPOSIÇÃO

Lente refletiva



REPOSIÇÃO	EMB.
PL0717.00.09	15

REF. ORIGINAL 002 544 18 90

Com lente de borda reforçada e fios para conexão



CÓDIGO	DESCRIÇÃO	LADO	EMB.
PL0716.21.09	Sem vigia	Direito	05
PL0716.22.09	Com vigia	Esquerdo	05



P21W (1141)
Freio
Luz de ré
Direcional



RSW (67)
Posição
Não acompanha lâmpada

Com conector 7 vias e borda reforçada



CÓDIGO	DESCRIÇÃO	LADO	REF. ORIGINAL	EMB.
PL0716.47.09	Sem vigia	Direito	958 540 01 70	05
PL0716.48.09	Com vigia	Esquerdo	958 540 02 70	05

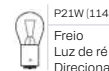

P21W (1141)
Freio
Luz de ré
Direcional



RSW (67)
Posição
Não acompanha lâmpada

Com conector
7 vias



REPOSIÇÃO

Máscara em ABS
para lanternas PL0716



REPOSIÇÃO	EMB.
PL0715.00.17	10

Lente com borda reforçada



REPOSIÇÃO	EMB.
PL0717.33.09	15

REPOSIÇÃO

Chicote 7 vias fêmea
com 20cm de cabos



CÓDIGO	EMB.
PL9947.39.00	10

Lente com borda reforçada



REPOSIÇÃO	EMB.
PL0717.33.09	15

PL 0716

Lanterna traseira
para caminhões Ford / MB

Com conector 5 vias e lente em acrílico

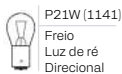

Não acompanha lâmpada

CÓDIGO	DESCRIÇÃO	LADO	REF. ORIGINAL	EMB.
PL0716.41.29	Sem vigia	Direito	688 544 92 03 CC 4513 405 AB	04
PL0716.42.29	Com vigia	Esquerdo	688 544 91 03 CC 4513 404 AB	04

Com conector 5 vias e lente com borda reforçada

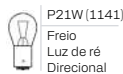

Não acompanha lâmpada

CÓDIGO	DESCRIÇÃO	LADO	EMB.
PL0716.31.09	Sem vigia	Direito	04
PL0716.32.09	Com vigia	Esquerdo	04

REPOSIÇÃO

Lente refletiva com borda reforçada



REPOSIÇÃO	EMB.
PL0717.33.09	15

Chicote 5 vias fêmea



CÓDIGO	EMB.
PL9999.17.97	15

PL 0912 LED

Lanterna traseira LED
Com conector tipo original e lente em acrílico
Aplicação MB Axor, Accelo e Atego

LED24V



Com sirene de ré

CÓDIGO	DESCRIÇÃO	LADO	EMB.
PL0912.31.69	Com 64 LEDs, sem vigia	Direito	01

Sem sirene de ré

CÓDIGO	DESCRIÇÃO	LADO	EMB.
PL0912.33.69	Com 64 LEDs, sem vigia	Direito	01
PL0912.34.69	Com 70 LEDs, com vigia	Esquerdo	01

PL 0912

Lanterna traseira
com conector tipo original e lente em acrílico
Aplicação MB Actros, Accelo Atego e Axor

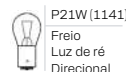

Não acompanha lâmpada



Com sirene de ré

CÓDIGO	DESCRIÇÃO	LADO	REF. ORIGINAL	EMB.
PL0912.31.29	Sem vigia	Direito	A 003 544 10 03	01

Sem sirene de ré

CÓDIGO	DESCRIÇÃO	LADO	REF. ORIGINAL	EMB.
PL0912.41.29	Sem vigia	Direito	A 003 544 08 03	01
PL0912.42.29	Com vigia	Esquerdo	A 003 544 61 03	01

REPOSIÇÃO

Lente em acrílico



CÓDIGO	EMB.
PL0913.00.29	10

REF. ORIGINAL A 002 544 63 03

Chicote com conector 7 vias tipo MB



CÓDIGO	EMB.
PL9986.00.97	10

PL 0914 LED

Lanterna traseira LED
Aplicação VW Actros 2021/22/23

LED24V



Com sirene de ré

CÓDIGO	DESCRIÇÃO	LADO	EMB.
PL0914.31.69	Sem vigia	Direito	01

REF. ORIGINAL 0035443403

Vista traseira



Sem sirene de ré

CÓDIGO	DESCRIÇÃO	LADO	REF. ORIGINAL	EMB.
PL0914.41.69	Sem vigia	Direito	0035443403	01
PL0914.42.69	Com vigia	Esquerdo	0035443203	01

REPOSIÇÃO

Chicote com conector 7 vias tipo MB



CÓDIGO	EMB.
PL9986.00.97	10

PL 0916

Lanterna traseira
Aplicação MB Axor e Actros

Com conector

Vista parte lateral



CÓDIGO	DESCRIÇÃO	LADO	REF. ORIGINAL	EMB.
PL0916.41.09	Sem vigia	Direito	A 001 540 63 70	01
PL0916.42.09	Com vigia	Esquerdo	A 001 540 62 70	01

Com terminais para adaptação

Vista parte lateral



CÓDIGO	DESCRIÇÃO	LADO	EMB.
PL0916.13.09	Sem vigia	Direito	01
PL0916.14.09	Com vigia	Esquerdo	01



Não acompanha lâmpada

REPOSIÇÃO

Lente refletiva



CÓDIGO	LADO	EMB.
PL0917.01.09	Direito	10
REF. ORIGINAL A 002 544 16 90 LD		
PL0917.02.09	Esquerdo	10
REF. ORIGINAL A 002 544 12 90 LE		

Chicote 7 vias fêmea com 20cm de cabos



CÓDIGO	EMB.
PL9947.39.00	10

SC NTG



SC SÉRIE 5



SC SÉRIE 4



SC SÉRIE 113



SC SÉRIE 113



PL0540



PL0446



PL0614

PL 6042

Farol principal com soquete tipo original

Aplicação SC NTG



H21W

Direcional



H7

Farol alto

Farol baixo

Não acompanha lâmpada



Conector tipo original

CÓDIGO	LADO	REF. ORIGINAL	EMB.
PL6042.01.02	Direito	1EH014541061	01
PL6042.02.02	Esquerdo	1EH014541051	01

PL 6076

Farol principal

Aplicação SC NTG



H4

Farol



P21W (1141)

Direcional

Não acompanha lâmpada



Conector tipo original

CÓDIGO	LADO	REF. ORIGINAL	EMB.
PL6076.01.02	Direito	2414344	01
PL6076.02.02	Esquerdo	2414343	01

PL 6074

Farol principal

Aplicação SC Série 4 1997 até 2008



Vista traseira



H4

Farol

Não acompanha lâmpada

CÓDIGO	LADO	Ref. Original	EMB.
PL6074.01.02	Direito	1733230	01
PL6074.02.02	Esquerdo	1733229	01

Farol principal com lanterna



Vista traseira



H4

Farol

Não acompanha lâmpada

CÓDIGO	LADO	EMB.
PL6074.91.22	Direito	01
PL6074.92.22	Esquerdo	01

REPOSIÇÃO

Lanterna direcional

Aplicação SC Série 4 Hella e Cibie



CÓDIGO	LADO	EMB.
PL1446.01.02	Direito	08
PL1446.02.02	Esquerdo	08

Chicote com 4 soquetes padrão Hella e conector



CÓDIGO	EMB.
PL9954.17.00	05

PL 6028

Farol principal

Sem luz de posição
Aplicação caminhões Série 5 / 6



CÓDIGO	LADO	REF. ORIGINAL	EMB.
PL6028.01.02	Direito	1949908	01
PL6028.02.02	Esquerdo	1949906	01



Farol principal com lanterna



CÓDIGO	LADO	EMB.
PL6028.91.22	Direito	01
PL6028.92.22	Esquerdo	01

Farol principal máscara negra



CÓDIGO	LADO	EMB.
PL6028.21.02	Direito	01
PL6028.22.02	Esquerdo	01

Farol principal máscara negra com lanterna

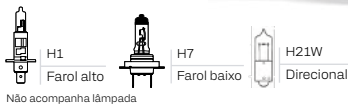

CÓDIGO	LADO	EMB.
PL6028.93.22	Direito	01
PL6028.94.22	Esquerdo	01

REPOSIÇÃO

Lanterna direcional LED com luz diurna

LED 24V



CÓDIGO	Ref. Original	EMB.
PL1544.41.61	2241544	01

Com máscara negra



CÓDIGO	EMB.
PL1544.21.61	01

Lente em policarbonato



CÓDIGO	LADO	EMB.
PL6029.01.22	Direito	05
PL6029.02.22	Esquerdo	05

Kit com presilhas de aço



CÓDIGO	EMB.
PL6028.00.00	10

PL 6064

Farol LED grade superior

Aplicação SC NTG



LED BIVOLT

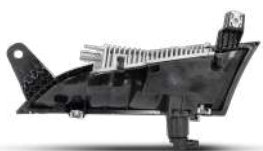

CÓDIGO	LADO	REF. ORIGINAL	EMB.
PL6064.01.62	Direito	2552712	01
PL6064.02.62	Esquerdo	2552711	01

PL 6078

Farol auxiliar LED de neblina

Aplicação SC NTG



LED BIVOLT



CÓDIGO	LADO	REF. ORIGINAL	EMB.
PL6078.01.02	Direito	2552715	01
PL6078.02.02	Esquerdo	2552714	01

PL 6060

Farol auxiliar LED - Cabine alta com leito

Aplicação SC NTG R / S / V8



LED BIVOLT



CÓDIGO	LADO	REF. ORIGINAL	EMB.
PL6060.01.62	Direito	2535367	01
PL6060.02.62	Esquerdo	2535366	01

PL 6062

Farol auxiliar LED - Cabine alta

Aplicação SC NTG G / P



LED BIVOLT



CÓDIGO	LADO	REF. ORIGINAL	EMB.
PL6062.01.62	Direito	2552709	01
PL6062.02.62	Esquerdo	2552708	01

PL 6112

Farol auxiliar de neblina
sem soquete Externo
Aplicação SC série 4 e Série 5



CÓDIGO	LADO	REF. ORIGINAL	EMB.
PL6112.21.02	Direito	1446356	01
PL6112.22.02	Esquerdo	1446355	01

REPOSIÇÃO

Lente em vidro



CÓDIGO	LADO	EMB.
PL6013.01.02	Direito	01
REF. ORIGINAL	1852572	
PL6013.02.02	Esquerdo	01
REF. ORIGINAL	1852571	

Soquete com 1 polo em nylon



CÓDIGO	EMB.
PL9929.17.97	10

PL 6114

Farol auxiliar de milha
sem soquete Interno
Aplicação SC Série 4 e Série 5



CÓDIGO	LADO	REF. ORIGINAL	EMB.
PL6114.21.02	Direito	1446354	01
PL6114.22.02	Esquerdo	1446353	01

REPOSIÇÃO

Lente em vidro



CÓDIGO	LADO	EMB.
PL6015.01.02	Direito	01
REF. ORIGINAL	1852570	
PL6015.02.02	Esquerdo	01
REF. ORIGINAL	1852569	

Soquete com 1 polo em nylon



CÓDIGO	EMB.
PL9929.17.97	10

PL 6118

Farol auxiliar DRL LED
Aplicação SC Série 5 / Streamline



LED 24V



REPOSIÇÃO

Chicote universal
com conector
ultra seal 2 vias



CÓDIGO	LADO	REF. ORIGINAL	EMB.
PL6118.01.62	Direito	2127432	01
PL6118.02.62	Esquerdo	2127431	01

CÓDIGO	EMB.
PL9946.17.00	10

PL 6016

Farol auxiliar de neblina e milha
com soquete tipo original
Aplicação SC 124



CÓDIGO	LADO	REF. ORIGINAL	EMB.
PL6016.01.02	Direito	1529071	01
PL6016.02.02	Esquerdo	1529070	01

PL 1544

Lanterna direcional LED com luz diurna
Com lente em acrílico
Aplicação SC Série 5

LED 24V

Com máscara negra



REPOSIÇÃO

Chicote com
conector 6 vias



CÓDIGO	Ref. Original	EMB.
PL1544.41.61	2241544	01

CÓDIGO	EMB.
PL1544.21.61	01

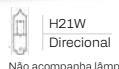

CÓDIGO	EMB.
PL9988.00.97	10

PL 1446

Lanterna direcional
Aplicação SC Série 4 Hella e Cibie



REPOSIÇÃO

Chicote com 4
soquetes
padrão Hella e conector



CÓDIGO	LADO	Ref. Original	EMB.
PL1446.01.02	Direito	1349784 ou 1407946	08
PL1446.02.02	Esquerdo	1349783 ou 1407945	08

CÓDIGO	EMB.
PL9954.17.00	05

PL 0478

Lanterna direcional
com lente em acrílico e sem soquete
Aplicação SC Série 5



CÓDIGO	REF. ORIGINAL	EMB.
PL0478.00.21	1774632	08

REPOSIÇÃO

Soquete com 1
polo tipo SC



CÓDIGO	EMB.
PL9955.17.00	10

PL 0764

Lanterna delimitadora LED
com conector tipo original
Com lente em acrílico
Aplicação SC NTG

LED 24V



CÓDIGO	LADO	Ref. Original	EMB.
PL0764.41.21	Direito	2334727	02
PL0764.42.21	Esquerdo	2334728	02

PL 0446

Lanterna direcional e posição
Aplicação SC 112 / 113

Sem refletivo



R5W (67)
Posição

P21W (1141)
Direcional

Não acompanha lâmpada

CÓDIGO	LADO	REF. ORIGINAL	EMB.
PL0446.01.06	Direito	289 928	07
PL0446.02.06	Esquerdo	289 927	07

Com refletivo



R5W (67)
Posição

P21W (1141)
Direcional

Não acompanha lâmpada

CÓDIGO	LADO	REF. ORIGINAL	EMB.
PL0446.11.06	Direito	394767	07
PL0446.12.06	Esquerdo	394766	07

Fumê com refletivo



R5W (67)
Posição

P21W (1056)
Direcional

Não acompanha lâmpada

CÓDIGO	LADO	REF. ORIGINAL	EMB.
PL0446.11.04	Direito	526618	07
PL0446.12.04	Esquerdo	526617	07

PL 0510

Lanterna delimitadora com base curva
Aplicação SC 111



P21W (1141)
Direcional

R5W (67)
Posição

Não acompanha lâmpada

CÓDIGO	REF. ORIGINAL	EMB.
PL0510.35.01	61 503	10



Vista parte traseira

REPOSIÇÃO

Lente



CÓDIGO	EMB.
PL0511.00.01	25
REF. ORIGINAL	98 000 822 86 10

PL 0772

Lanterna LED do estribo
Aplicação SC NTG

LED BIVOLT



Vista parte traseira

CÓDIGO	REF. ORIGINAL	EMB.
PL0772.00.61	1928063	02

PL 0484

Refletivo delimitador
Aplicação SC Série 4

Lanterna Com LED

LED BIVOLT

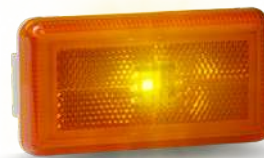

CÓDIGO	Ref. Original	EMB.
PL0484.00.01	1362707	10

CÓDIGO	EMB.
PL0484.00.41	10

PL 0750

Lanterna delimitadora LED
com refletivo e soquete tipo original
Aplicação SC Série 6

LED24V



Vista parte traseira

CÓDIGO	REF. ORIGINAL	EMB.
PL0750.24.61	2052119 / 2080828	02

REPOSIÇÃO

Chicote com conector 2 vias



CÓDIGO	EMB.
PL9998.17.97	10

PL 1624

Lanterna LED tapa sol
Aplicação SC NTG

LED BIVOLT



Vista parte traseira

CÓDIGO	REF. ORIGINAL	EMB.
PL1624.41.62	2252783	02

PL 1454

Lanterna delimitadora
Aplicação SC Série 4 e Série 5

Com LED **LED24V**



CÓDIGO EMB.
PL1454.24.62 10

Com conector tipo original e LED **LED24V**



CÓDIGO EMB.
PL1454.41.62 10
REF. ORIGINAL 2035104 ou 1798980



CÓDIGO EMB.
PL1454.41.61 10

PRODUTO ESPECIAL,
DISPONÍVEL MEDIANTE CONSULTA.

REPOSIÇÃO

Chicote com conector 2 vias



CÓDIGO EMB.
PL9998.17.97 10

PL 0438

Lanterna delimitadora sem soquete
Aplicação SC 113



CÓDIGO REF. ORIGINAL EMB.
PL0438.00.02 199 846 10



R5W (67)
Posição

Não acompanha lâmpada

REPOSIÇÃO

Chicote com soquete de 1 polo tipo ônibus



CÓDIGO EMB.
PL9911.17.97 10

PL 0540

Lanterna delimitadora com base curva
Aplicação SC (a partir de 94)



Vista parte traseira



CÓDIGO REF. ORIGINAL EMB.
PL0540.00.07 301844 5



R5W (67)
Posição

Não acompanha lâmpada

PL 1614

Lanterna traseira
Aplicação SC Série 4



CÓDIGO DESCRIÇÃO LADO REF. ORIGINAL EMB.
PL1614.01.09 Sem vigia Direito 1387878 ou 1436868 03
PL1614.02.09 Com vigia Esquerdo 1387877 ou 1436867 03



R5W (67)
Posição

Não acompanha lâmpada



Vista parte traseira

152mm

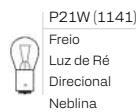

P21W (1141)
Freio
Luz de Ré
Direcional
Neblina

REPOSIÇÃO

Lente em acrílico



CÓDIGO REF. ORIGINAL EMB.
PL1615.00.09 1380819 15

PL 0614

Lanterna traseira
Aplicação SC (a partir de 89)



Vista parte traseira

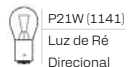

P21W (1141)
Luz de Ré
Direcional

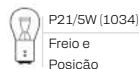

P21/5W (1034)
Freio e
Posição

Não acompanha lâmpada

CÓDIGO DESCRIÇÃO LADO REF. ORIGINAL EMB.
PL0614.01.09 Sem vigia Direito 527064 01
PL0614.02.09 Com vigia Esquerdo 527065 01

REPOSIÇÃO

Lente sem vigia



CÓDIGO LADO REF. ORIGINAL EMB.
PL0615.01.09 Direito 1670292 05

Lente com vigia



CÓDIGO LADO REF. ORIGINAL EMB.
PL0615.02.09 Esquerdo 1670289 05

PL 1456

Lanterna traseira LED com conector tipo original
Lente em acrílico
Aplicação SC NTG



LED24V



Vista parte traseira

Sem sirene de ré
CÓDIGO DESCRIÇÃO LADO REF. ORIGINAL EMB.
PL1456.01.67 Sem vigia Direito 2860826 01
PL1456.02.67 Com vigia Esquerdo 2860829 01

Com sirene de ré
CÓDIGO DESCRIÇÃO LADO EMB.
PL1456.31.67 Sem vigia Direito 01

REPOSIÇÃO

Chicote 7 vias fêmea com 20cm de cabos



CÓDIGO EMB.
PL9947.39.00 10

PL 1442

Lanterna traseira LED com conector tipo original
Lente em acrílico
Aplicação SC

LED 24V

Sem sirene



Com sirene



CÓDIGO	DESCRIÇÃO	LADO	REF. ORIGINAL	EMB.
PL1442.01.67	Sem vigia	Direito	1905043	01
PL1442.02.67	Com vigia	Esquerdo	1905044	01

CÓDIGO	DESCRIÇÃO	LADO	REF. ORIGINAL	EMB.
PL1442.31.67	Sem vigia	Direito	2380953	01

REPOSIÇÃO

Lente em acrílico



CÓDIGO	LADO	REF. ORIGINAL	EMB.
PL1443.01.67	Direito	2027555	02
PL1443.02.67	Esquerdo	2027556	02

Kit com 6 grampos especiais
para fixação da lente



CÓDIGO	EMB.
PL1443.00.00	06

Chicote 7 vias fêmea
com 20cm de cabos



CÓDIGO	EMB.
PL9947.39.00	10

PL 1616

Lanterna traseira
Aplicação SC

Com conector tipo original



- P21W (1141)
Freio
Luz de Ré
Neblina
 - PY21W (1056)
Direcional
 - RSW (67)
Posição
- Não acompanha lâmpada

CÓDIGO	DESCRIÇÃO	LADO	REF. ORIGINAL	EMB.
PL1616.41.07	Sem vigia	Direito	2021575 ou 1756751	01
PL1616.42.07	Com vigia	Esquerdo	2021579 ou 1756754	01

Com LED e conector tipo original

LED BIVOLT



CÓDIGO	DESCRIÇÃO	LADO	EMB.
PL1616.21.47	Com 36 LEDs - Sem vigia	Direito	01
PL1616.22.47	Com 38 LEDs - Com vigia	Esquerdo	01

Com cabos para adaptação



- P21W (1141)
Freio
Luz de Ré
Neblina
 - PY21W (1056)
Direcional
 - RSW (67)
Posição
- Não acompanha lâmpada

CÓDIGO	DESCRIÇÃO	LADO	EMB.
PL1616.01.07	Sem vigia	Direito	01
PL1616.02.07	Com vigia	Esquerdo	01

REPOSIÇÃO

Lente



Chicote 7 vias fêmea
com 20cm de cabos



CÓDIGO	LADO	REF. ORIGINAL	EMB.
PL1617.01.07	Direito	1784670	10
PL1617.02.07	Esquerdo	1784669	10

CÓDIGO	EMB.
PL9947.39.00	10

VW CONSTELLATION



KIT RETROFIT

 PL7000	 PL0986	 Soquete disponível PL9928	 Soquete disponível PL9930	 PL7054	 PL7038	 Chicote disponível PL9977	
 PL6050	 Chicote disponível PL9996	 PL0270	 Soquete disponível PL9913	 PL0898	 Chicote disponível PL9946	 PL0988	 Chicote disponível PL9981
 PL0896	 Soquetes disponíveis PL9924	 Soquetes disponíveis PL9926	 Chicote disponível PL9996	 PL0482	 Chicotes disponíveis PL9983	 Chicotes disponíveis PL9985	

VW CONSTELLATION



 PL7036	 PL0988	 PL6050	 Chicote disponível PL9996
 PL0270	 Soquete disponível PL9913	 PL0898	 Chicote disponível PL9946
 PL0896	 Soquetes disponíveis PL9924	 Soquetes disponíveis PL9926	 Chicote disponível PL9996

MAN TGX



 PL6040	 PL6041		
 PL6026	 PL6027	 PL1622	
 PL0890	 PL0530	 PL1618	 Chicote disponível PL9947

VW METEOR



 PL6040	 PL6041		
 PL6026	 PL6027	 PL1622	
 PL0898	 Chicote disponível PL9946	 PL0996	 Chicote disponível PL9997

VW DELIVERY EURO 6



VW DELIVERY EURO 5



Chicotes disponíveis

VW DELIVERY

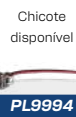

VW DELIVERY



VW WORKER



VW TITAN



PL 7018

Farol duplo com moldura prata
Aplicação caminhões VW Titan 2000 a 2002



H1
Farol Não acompanha lâmpada

CÓDIGO	LADO	REF. ORIGINAL	EMB.
PL7018.01.22	Direito	2RG941008374	01
PL7018.02.22	Esquerdo	2RG941007374	01



Vista parte traseira

PL 7020

Farol duplo com moldura preta
Aplicação caminhões VW Titan a partir de 2003



H1
Farol Não acompanha lâmpada

CÓDIGO	LADO	REF. ORIGINAL	EMB.
PL7020.01.22	Direito	2S0941008B41	01
PL7020.02.22	Esquerdo	2S0941007B41	01



Vista parte traseira

REPOSIÇÃO

Módulo óptico



CÓDIGO	LADO	EMB.
PL7003.01.22	Direito	01
PL7003.02.22	Esquerdo	01

Soquete 1 polo para faróis MB / VW



CÓDIGO	EMB.
PL9976.1797	10

Máscara prata



CÓDIGO	LADO	EMB.
PL7019.01.19	Direito	02
PL7019.02.19	Esquerdo	02

Máscara preta



CÓDIGO	LADO	EMB.
PL7021.01.17	Direito	02
PL7021.02.17	Esquerdo	02

PL 7000

Farol principal

com guarda pó
Com lente em policarbonato
Aplicação caminhões VW Constellation



H4
Farol

Não acompanha lâmpada

CÓDIGO	LADO	REF. ORIGINAL	EMB.
PL7000.01.22	Direito	2R2941032	01
PL7000.02.22	Esquerdo	2R2941031	01



Vista parte traseira

REPOSIÇÃO

Módulo óptico



CÓDIGO	LADO	EMB.
PL7001.01.22	Direito	01
PL7001.02.22	Esquerdo	01

PL 7036

Farol principal com DRL LED

Com motor de regulagem automática
Com lente em policarbonato
Aplicação caminhões VW Constellation a partir de 2023



LED BIVOLT



H4
Farol

Não acompanha lâmpada

CÓDIGO	LADO	REF. ORIGINAL	EMB.
PL7036.01.62	Direito	23K941034	01
PL7036.02.62	Esquerdo	23K941033	01



Vista parte traseira

PL 7038

Farol principal com posição LED

Com lente em policarbonato
Aplicação caminhões VW Constellation até 2022
Modelo adaptação



LED BIVOLT



H4
Farol

Não acompanha lâmpada

CÓDIGO	LADO	REF. ORIGINAL	EMB.
PL7038.01.62	Direito	2R2941032	01
PL7038.02.62	Esquerdo	2R2941031	01

REPOSIÇÃO

Chicote adaptador com conectores



CÓDIGO	EMB.
PL9977.00.00	01

Atualize o seu Constellation

Kit completo para modernização do Constellation

Modelos fabricados até 2022



com original

com kit VW

Kit PL7038.09.88

PL7038.01.62 - LD (01un)
PL7038.02.62 - LE (01un)
PL0988.01.42 - LD (01un)
PL0988.02.42 - LE (01un)
PL9977.00.00 (2un)
PL9981.00.00 (2un)

Kit PL7038.99.99

PL7038.01.62 - LD (01un)
PL7038.02.62 - LE (01un)
PL0988.01.42 - LD (01un)
PL0988.02.42 - LE (01un)
PL9977.00.00 (2un)
PL9981.00.00 (2un)
PL0270.00.42 (2un)
PL0896.24.61 (2un)
PL6050.24.62 (2un)

Todos os produtos em LED's



PL 7040

Farol principal com Daylight LED
Aplicação caminhões VW Delivery Euro 5 de 2018 até 2023



LED BIVOLT



Único com sistema de **dupla iluminação** da luz de posição.

- Maior intensidade de luz
- Maior visibilidade
- Mais segurança

CÓDIGO	LADO	REF. ORIGINAL	EMB.	H4 Farol	PY21W (1056) Direcional
PL7040.01.22	Direito	23B 941 034A	01	Não acompanha lâmpada	
PL7040.02.22	Esquerdo	23B 941 033A	01		

PL 7044

Farol principal com Daylight LED
Com motor de regulação automática
Funções DRL, posição e direcional com LED
Aplicação caminhões VW Delivery Euro 6 a partir de 2023



Não acompanha lâmpada

CÓDIGO	TENSÃO	LADO	EMB.	Aplicação caminhões VW Delivery até 2023
PL7044.11.62	LED 12V	Direito	01	CÓDIGO TENSÃO LADO EMB.
PL7044.12.62	LED 12V	Esquerdo	01	
PL7044.33.62	LED 24V	Direito	01	PL7044.01.62 LED 12V Direito 01
PL7044.34.62	LED 24V	Esquerdo	01	PL7044.02.62 LED 12V Esquerdo 01

PL 7042

Farol auxiliar
Aplicação caminhões VW Delivery Euro 5 de 2018 até 2023



CÓDIGO	LADO	REF. ORIGINAL	EMB.	H7 Farol
PL7042.01.22	Direito	23B 941 206	01	Não acompanha lâmpada
PL7042.02.22	Esquerdo	23B 941 205	01	

PL 7042

Farol auxiliar full LED
Aplicação caminhões VW Delivery Euro 6 a partir de 2023

LED BIVOLT



CÓDIGO	LADO	EMB.
PL7042.01.62	Direito	01
PL7042.02.62	Esquerdo	01

PL 6026

Farol auxiliar de neblina
Aplicação caminhões MAN TGX / Meteor

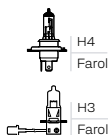

CÓDIGO	LADO	REF. ORIGINAL	EMB.
PL6026.01.02	Direito	81251016522 2V5941064	01
PL6026.02.02	Esquerdo	81251016521 2V5941063	01

Não acompanha lâmpada

PL 6040

Farol principal com DRL
Aplicação MAN TGX / Meteor

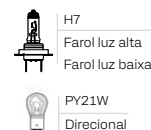

CÓDIGO	LADO	REF. ORIGINAL	EMB.
PL6040.01.22	Direito	81251016498	01
PL6040.02.22	Esquerdo	81251016499	01

Não acompanha lâmpada

REPOSIÇÃO

Lente em vidro



Conector tipo original



CÓDIGO	LADO	EMB.
PL6027.01.22	Direito	01
PL6027.02.22	Esquerdo	01

REPOSIÇÃO

Lente em vidro



Conector tipo original



CÓDIGO	LADO	EMB.
PL6041.01.22	Direito	01
PL6041.02.22	Esquerdo	01

PL 6050

Farol auxiliar LED
Com conector e lente em acrílico
Aplicação VW Constellation

LED 24V



112mm



Conector tipo original

REPOSIÇÃO

Chicote com conector 2 vias para luz de posição



CÓDIGO	EMB.
PL6050.24.62	01

CÓDIGO	EMB.
PL9996.17.97	10

PL 7054

Farol de neblina
Aplicação MB 1938 / 1620 / 1214 Accelo e VW Constellation



112mm



Conector tipo original

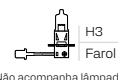

CÓDIGO	REF. ORIGINAL	EMB.
PL7054.00.22	A6448205856 / 2T2941063	01

PL 7022

Farol Luz Alta e baixa
Aplicação caminhões VW Delivery



REPOSIÇÃO

Módulo óptico



Não acompanha lâmpada



CÓDIGO	LADO	REF. ORIGINAL	EMB.
PL7022.01.22	Direito	2P0.941.008	01
PL7022.02.22	Esquerdo	2P0.941.007	01

CÓDIGO	LADO	EMB.
PL7023.01.22	Direito	01
REF. ORIGINAL	EC45 13005	
PL7023.02.22	Esquerdo	01
REF. ORIGINAL	EC45 13006	

PL 0662

Lanterna LED direcional e posição
Aplicação VW e delivery

LED BIVOLT



Vista traseira

REPOSIÇÃO

Chicote com conector ultra seal 3 vias



CÓDIGO	EMB.
PL0662.41.61	10
REF. ORIGINAL	12V - 23B 953 037A 24V - 23B 953 037

CÓDIGO	EMB.
PL9997.37.97	10

PL 0986

Lanterna direcional
Aplicação VW Constellation

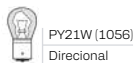

Não acompanha lâmpada

REPOSIÇÃO

Soquete em nylon tipo VW para posição



CÓDIGO	EMB.
PL9928.17.97	20

Soquete em nylon tipo VW para direcional



CÓDIGO	EMB.
PL9930.17.97	10

Sem soquete

CÓDIGO	LADO	REF. ORIGINAL	EMB.
PL0986.01.02	Direito	2122949102ALD	08
PL0986.02.02	Esquerdo	2122949101ALE	08

Com soquete

CÓDIGO	LADO	EMB.
PL0986.41.02	Direito	01
PL0986.42.02	Esquerdo	01

PL 0988

Lanterna direcional LED com angel eyes
Com conector
Aplicação VW Constellation a partir de 2023

LED 24V



REPOSIÇÃO

Chicote adaptador com conectores para PL0988 Aplicação em todos os anos



CÓDIGO	LADO	REF. ORIGINAL	EMB.
PL0988.01.42	Direito	23H949102	01
PL0988.02.42	Esquerdo	23H949101	01

CÓDIGO	EMB.
PL9981.00.00	10

Não necessita alterar chicote original; Deixa o caminhão mais bonito e moderno; Montagem prática em menos de 5 minutos.

PL 0598

Lanterna posição / delimitadora
Com lente em acrílico
Aplicação VW e universal

Com LED e cabos para adaptação **LED BIVOLT**



CÓDIGO	EMB.	CÓDIGO	EMB.
PL0598.00.61	10	PL0598.00.62	10

Sem soquete



CÓDIGO	EMB.	CÓDIGO	EMB.
PL0598.00.21	10	PL0598.00.22	10

REF. ORIGINAL W3A 0491 01A

Com soquete



CÓDIGO	EMB.	CÓDIGO	EMB.
PL0598.41.21	10	PL0598.41.22	10

WSW
Delimitadora
Não acompanha lâmpada

Com soquete tipo adaptação



CÓDIGO	EMB.	CÓDIGO	EMB.
PL0598.13.21	10	PL0598.13.22	10

T4W (69)
Posição
Não acompanha lâmpada

REPOSIÇÃO

Soquete com 1 polo universal e VW



CÓDIGO	EMB.
PL9914.17.96	20

Chicote com conector 2 vias tipo MB



CÓDIGO	EMB.
PL9994.17.97	10

Soquete com 1 polo universal e VW



CÓDIGO	EMB.
PL9913.17.97	20

PL 0896

Lanterna direcional
Aplicação VW Constellation

Com LED, lente em acrílico e fios para adaptação



CÓDIGO	EMB.	CÓDIGO	EMB.
PL0896.24.61	05	PL0896.24.62	05

COM LED AMARELO

Vista parte lateral

Sem soquete



CÓDIGO	EMB.	CÓDIGO	EMB.
PL0896.00.01	05	PL0896.00.02	05

REF. ORIGINAL 2R2 953 037

CÓDIGO	LENTE	EMB.	CÓDIGO	LENTE	EMB.
PL0896.00.21	Acrílica	05	PL0896.00.22	Acrílica	05

Com soquete



CÓDIGO	LENTE	EMB.	CÓDIGO	EMB.
PL0896.41.01	-	05	PL0896.41.02	05
PL0896.41.21	Acrílica	05		

WSW
Posição

P21W (1141)
Direcional

PY21W (1056)
Direcional
Não acompanha lâmpada

Chicote com conector 2 vias para luz de posição



CÓDIGO	EMB.
PL9996.17.97	10

Chicote universal com conector ultra seal 2 vias



CÓDIGO	EMB.
PL9946.17.00	10

PL 0534

Lanterna direcional
Aplicação VW

Com cúpula



CÓDIGO	EMB.	CÓDIGO	EMB.
PL0534.00.01	10	PL0534.03.02	10

REF. ORIGINAL TAC 953 041

P21W
Direcional
Não acompanha lâmpada

Novo encaixe



Vista traseira

Suporte metálico não disponível

REPOSIÇÃO

Lente



CÓDIGO	EMB.	CÓDIGO	EMB.
PL0535.00.01	10	PL0535.00.02	10

REF. ORIGINAL T12 953 141

REF. ORIGINAL 2TA 953 161

PL 0572

Lanterna delimitadora
Aplicação ônibus e caminhões VW



RSW (67)
Posição
Não acompanha lâmpada

Com soquete para adaptação



CÓDIGO	EMB.
PL0572.41.01	10

REF. ORIGINAL 1A8 508 910 6

Sem soquete tipo original



CÓDIGO	EMB.
PL0572.00.01	10

REPOSIÇÃO

Lente



CÓDIGO	EMB.
PL0573.00.01	20

REF. ORIGINAL TAC 949 101

PL 0890

Lanterna direcional
Com lente em acrílico
Aplicação MAN



CÓDIGO	EMB.	RY10W	Direcional
PL0890.00.22	10	✓	✓
REF. ORIGINAL	81.25320.6116	Não acompanha lâmpada	

PL 0996

Lanterna direcional e delimitadora LED
Com lente em acrílico



Delivery **LED 12V** Meteor **LED 24V**

CÓDIGO	EMB.	CÓDIGO	EMB.
PL0996.12.61	04	PL0996.24.61	04
REF. ORIGINAL	21P953037	REF. ORIGINAL	2S2953037



Vista parte traseira

REPOSIÇÃO

Chicote com conector ultra seal 3 vias



CÓDIGO	EMB.
PL9997.37.97	10

PL 0530

Lanterna delimitadora LED
Com conector e lente acrílica
Aplicação caminhões MAN

LED 24V



CÓDIGO	REF. ORIGINAL	EMB.
PL0530.24.61	81.2560.6104	01

PL 0898

Lanterna delimitadora LED
Com conector e lente acrílica
Aplicação VW Constellation 25.390/ 26.390



CÓDIGO	REF. ORIGINAL	EMB.
PL0898.11.61	2V29491018	04

LED 24V

REPOSIÇÃO

Chicote universal com conector ultra seal 2 vias



CÓDIGO	EMB.
PL9946.17.00	10



Vista parte traseira

PL 0664

Lanterna delimitadora
Aplicação Delivery

Com LED **LED BIVOLT**



CÓDIGO	REF. ORIGINAL	EMB.
PL0664.41.62	23B945341	10



Vista traseira

REPOSIÇÃO

Chicote universal com conector ultra seal 2 vias



CÓDIGO	EMB.
PL9946.17.00	10

PL 0547

Refletivo dianteiro auto-adesivo
Aplicação VW 23.210 e outros



CÓDIGO	LADO	REF. ORIGINAL	EMB.
PL0547.01.01	Direito	2S0 945106	20
PL0547.02.01	Esquerdo	2S0 945105	20

De lâmpada



CÓDIGO	REF. ORIGINAL	EMB.
PL0664.41.22	23B945341D	10



Vista traseira

REPOSIÇÃO

Soquete em nylon tipo VW para posição



CÓDIGO	EMB.
PL9928.17.97	20

PL 0270

Lanterna delimitadora com parafusos embutidos na base
Aplicação caminhões Ford / VW

Com **LED BIVOLT**

Sem soquete



CÓDIGO	EMB.
PL0270.00.42	10



CÓDIGO	REF. ORIGINAL	EMB.
PL0270.00.02	2R2 945 341 A1	20



T4W (69) Posição
Não acompanha lâmpada

PL 0442

Lanterna delimitadora
Aplicação caminhões VW

Sem soquete



CÓDIGO	EMB.
PL0442.00.02	10
REF. ORIGINAL	2SS945051 ou 2TA945051B



T4W (69) Posição
Não acompanha lâmpada

Com **LED BIVOLT**



CÓDIGO	EMB.
PL0442.00.42	10



Vista parte frontal



Vista parte lateral



Vista parte de baixo

PL 0470

Conjunto óptico para lanternas delimitadoras PL0442 e PL0462

Sem soquete



CÓDIGO	REF. ORIGINAL	EMB.
PL0470.00.02	154 4287 TU	20



T4W (69) Posição
Não acompanha lâmpada

Com soquete



CÓDIGO	REF. ORIGINAL	EMB.
PL0470.41.02	2R2945341A1	20



T4W (69) Posição
Não acompanha lâmpada

Com LED **LED BIVOLT**



CÓDIGO	EMB.
PL0470.00.42	05

REPOSIÇÃO

Soquete com 1 polo



REPOSIÇÃO	EMB.
PL9913.17.97	20

PL 1622

Lanterna delimitadora LED
Com conector e lente acrílica
Aplicação MAN

LED BIVOLT



CÓDIGO	REF. ORIGINAL	EMB.
PL1622.41.62	81.252606121	05

PL 0554

Lanterna delimitadora
Aplicação ônibus e caminhões VW



CÓDIGO	EMB.
PL0554.00.01	15

CÓDIGO	EMB.
PL0554.00.02	15

REF. ORIGINAL 2TA 945 05 1B

RSW (67)
Posição
Não acompanha lâmpada

REPOSIÇÃO

Lente



CÓDIGO	EMB.
PL0555.00.02	15

REF. ORIGINAL 2TA 945 425

PL 0696

Lanterna delimitadora sem soquete
Aplicação caminhões VW



CÓDIGO	LADO	EMB.
PL0696.01.01	Direito	10

REF. ORIGINAL T12945362 ou 945 366

CÓDIGO	LADO	EMB.
PL0696.02.01	Esquerdo	10

REF. ORIGINAL T12945361 ou 945 365

CÓDIGO	LADO	EMB.
PL0696.01.02	Direito	10

REF. ORIGINAL T12945362 ou 945 366

CÓDIGO	LADO	EMB.
PL0696.02.02	Esquerdo	10

PL 0698

Lanterna delimitadora sem soquete
Aplicação caminhões VW



CÓDIGO	EMB.
PL0698.00.01	10

REF. ORIGINAL T12945362 ou 945 366

CÓDIGO	EMB.
PL0698.00.02	10

Sem soquete com parafusos



Vista parte traseira

CÓDIGO	LADO	EMB.
PL0696.21.01	Direito	10

CÓDIGO	LADO	EMB.
PL0696.22.01	Esquerdo	10

RSW (67)
Posição

Não acompanha lâmpada



Com parafusos

CÓDIGO	EMB.
PL0698.21.01	10

REF. ORIGINAL 945 365

Com soquete e parafusos

CÓDIGO	EMB.
PL0698.41.01	10

WSW
Posição

Não acompanha lâmpada

REPOSIÇÃO

Chicote com soquete de 1 polo tipo VW



CÓDIGO	EMB.
PL9906.17.00	10

PL 0482

Lanterna traseira
Com lente bolha / bojudá para caminhões VW

Com cabos

Com LED LED BIVOLT



CÓDIGO	DESCRIÇÃO	LADO	EMB.
PL0482.21.07	Sem vigia	Direito	06

REF. ORIGINAL 2S945096 ou 2R0945096E

CÓDIGO	DESCRIÇÃO	LADO	EMB.
PL0482.22.07	Com vigia	Esquerdo	06

REF. ORIGINAL 2S945095 ou 2R0945095H

CÓDIGO	DESCRIÇÃO	LADO	EMB.
PL0482.49.07	Sem vigia	Direito	06

REF. ORIGINAL 2S945096 ou 2R0945096E

CÓDIGO	DESCRIÇÃO	LADO	EMB.
PL0482.50.07	Com vigia	Esquerdo	06

REF. ORIGINAL 2S945095 ou 2R0945095H

Com lente em acrílico

CÓDIGO	DESCRIÇÃO	LADO	EMB.
PL0482.21.27	Sem vigia	Direito	06

REF. ORIGINAL 2S2945096

CÓDIGO	DESCRIÇÃO	LADO	EMB.
PL0482.22.27	Com vigia	Esquerdo	06

REF. ORIGINAL 2S2945095

P21W (1141)
Freio
Luz de ré

Não acompanha lâmpada

PY21W (1056)
Direcional

Não acompanha lâmpada

RSW
Posição

Não acompanha lâmpada

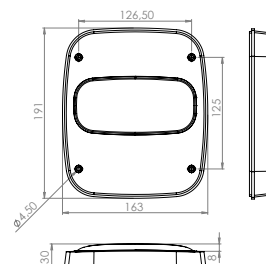

REPOSIÇÃO

Lente bicolor



CÓDIGO	EMB.
PL0483.21.07	30

REF. ORIGINAL 2R0945223A

* Produto não original desenho exclusivo com bolha

Chicote conector 6 vias - Macho



CÓDIGO	EMB.
PL9983.00.00	10

Chicote conector 6 vias - Fêmea



CÓDIGO	EMB.
PL9985.00.00	10

PL 0440 LED

Lanterna traseira LED
para caminhões Ford / VW



LED BIVOLT

CÓDIGO	DESCRIÇÃO	LADO	EMB.
PL0440.21.49	22 LEDs - Sem vigia	Direito	06
PL0440.22.49	24 LEDs - Com vigia	Esquerdo	06

Com lente lisa



LED BIVOLT

CÓDIGO	DESCRIÇÃO	LADO	EMB.
PL0440.23.49	22 LEDs - Sem vigia	Direito	06
PL0440.24.49	24 LEDs - Com vigia	Esquerdo	06

PL 0440

Lanterna traseira
para caminhões Ford / VW (VW de 89 a 2011)



CÓDIGO	DESCRIÇÃO	LADO	EMB.
PL0440.01.09	Sem vigia	Direito	06

REF. ORIGINAL Ford 98HU13404AA - VW T12 945 096

CÓDIGO	DESCRIÇÃO	LADO	EMB.
PL0440.02.09	Com vigia	Esquerdo	06

REF. ORIGINAL Ford 98HU13405AA - VW T12 945 095

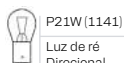

P21W (1141)

Luz de ré
Direcional



P21/5W (1034)

Freio e Posição

Não acompanha lâmpada

Lente tricolor

REPOSIÇÃO



REPOSIÇÃO	EMB.
PL0441.00.09	30

REF. ORIGINAL
T12 945 223 A

Com lente lisa



CÓDIGO	DESCRIÇÃO	LADO	EMB.
PL0440.23.09	Sem vigia	Direito	06
PL0440.24.09	Com vigia	Esquerdo	06



P21W (1141)

Luz de ré
Direcional



P21/5W (1034)

Freio e Posição

Não acompanha lâmpada

Lente lisa

REPOSIÇÃO



REPOSIÇÃO	EMB.
PL0441.23.09	30

Com lente bicolor



CÓDIGO	DESCRIÇÃO	LADO	EMB.
PL0440.01.07	Sem vigia	Direito	06
PL0440.02.07	Com vigia	Esquerdo	06



P21W (1141)

Luz de ré



P21/5W (1034)

Freio e Posição



PY21W (1056)

Direcional

Não acompanha lâmpada

Lente bicolor

REPOSIÇÃO



REPOSIÇÃO	EMB.
PL0441.00.07	30

PL 1618

Lanterna traseira
Aplicação caminhões MAN

Com conector



P21W (1141)

Freio
Luz de Ré
Neblina



PY21W (1056)

Direcional



RSW (67)

Posição

Não acompanha
lâmpada

CÓDIGO	DESCRIÇÃO	LADO	REF. ORIGINAL	EMB.
PL1618.41.11	Sem vigia	Direito	2V5945096C	01
PL1618.42.11	Com vigia	Esquerdo	2V5945095B	01

Com LED e conector

LED BIVOLT

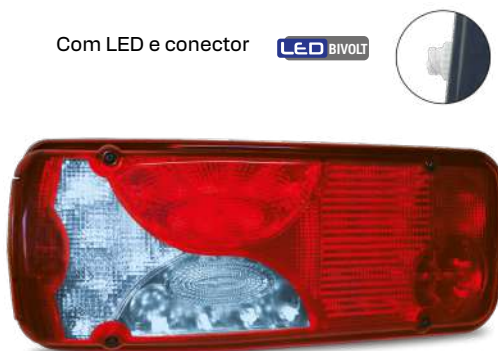

CÓDIGO	DESCRIÇÃO	LADO	EMB.
PL1618.21.51	Com 36 LEDs - Sem vigia	Direito	01
PL1618.22.51	Com 38 LEDs - Com vigia	Esquerdo	01

REPOSIÇÃO

Lente



REPOSIÇÃO	LADO	EMB.
PL1619.01.11	Direito	10

REF. ORIGINAL 2V5941112

REPOSIÇÃO	LADO	EMB.
PL1619.02.11	Esquerdo	10

REF. ORIGINAL 2V5945111

Chicote 7 vias fêmea
com 20cm de cabos



CÓDIGO	EMB.
PL9947.39.00	10

VL FH NEW



VL FH 4



VL FH 13



VL FH



VL FH 12



PL1708

Soquete disponível



PL9919



PL1710

Soquete disponível



PL9932



PL0706

Soquete disponível



PL9911



PL0728

Chicote disponível



PL9947

VL VM



PL6058



PL0740

Soquete disponível



PL9932



PL0710



PL1550

Chicote disponível



PL9947

VL VM



PL6020



PL0740

Soquete disponível



PL9932



PL0710



PL1550

Chicote disponível



PL9947

VL VM



PL6044



PL6045



PL0708

Soquete disponível



PL9921



PL0710



PL0728

Chicote disponível



PL9947

VL NH



VL NL



PL 6018

Farol principal com direcional
Com lente em policarbonato
LED luz diurna e soquete tipo original
Aplicação caminhões FH13 FM13 2009/2016



Conector tipo original

REPOSIÇÃO

Lente em policarbonato



H7
Farol



PY21W (1056)
Direcional

Não acompanha lâmpada

CÓDIGO	LADO	REF. ORIGINAL	EMB.
PL6018.01.22	Direito	21035637	01
PL6018.02.22	Esquerdo	21035638	01

REPOSIÇÃO	LADO	EMB.
PL6019.01.22	Direito	01
PL6019.02.22	Esquerdo	01

PL 6022

Farol principal
com lente em policarbonato
LED luz diurna e soquete tipo original
Aplicação caminhões FH14 FH16



Conector tipo original



H1
Farol



H7
Farol



PY21W (1056)
Direcional

Não acompanha lâmpada

CÓDIGO	LADO	REF. ORIGINAL	EMB.
PL6022.01.22	Direito	21221129	01
PL6022.02.22	Esquerdo	21221130	01

PL 6008

Farol auxiliar foco duplo
Com soquete tipo original
Aplicação caminhões FH16



CÓDIGO	LENTE	LADO	REF. ORIGINAL	EMB.
PL6008.01.22	Polycarbonato	Direito	21221153 - 82140763	01
PL6008.02.22	Polycarbonato	Esquerdo	21221154 - 82140744	01

Não acompanha lâmpada

PL 6010

Farol auxiliar foco simples
Com soquete tipo original
Aplicação caminhões FH16



CÓDIGO	LENTE	LADO	REF. ORIGINAL	EMB.
PL6010.01.22	Polycarbonato	Direito	21221151	01
PL6010.02.22	Polycarbonato	Esquerdo	21221152	01

Não acompanha lâmpada

PL 6020

Farol principal
com soquete tipo original e lente em polycarbonato
Aplicação caminhões VM 2006/2014



CÓDIGO	LADO	REF. ORIGINAL	EMB.
PL6020.01.22	Direito	20818771	01
PL6020.02.22	Esquerdo	20818763	01

Não acompanha lâmpada

PL 6058

Farol principal com DRL
Aplicação VL VM 2015



CÓDIGO	LADO	REF. ORIGINAL	EMB.
PL6058.01.02	Direito	82532284/84550050	01
PL6058.02.02	Esquerdo	82526640/84550049	01

Não acompanha lâmpada

PL 6080

Farol principal
Com lente em polycarbonato
LED luz diurna e soquete tipo original
Aplicação caminhões FHS



Não acompanha lâmpada

CÓDIGO	LADO	REF. ORIGINAL	EMB.
PL6080.01.22	Direito	23752668	01
PL6080.02.22	Esquerdo	23752664	01

PL 6068

Farol Auxiliar LED 2 pinos para foco simples

Aplicação VL New FH 2020 em diante

LED24V



CÓDIGO	LADO	REF. ORIGINAL	EMB.
PL6068.01.62	Direito	23752720	01
PL6068.02.62	Esquerdo	23752728	01

PL 6066

Farol Auxiliar LED 3 pinos para foco duplo

Aplicação VL New FH 2020 em diante.

LED24V



CÓDIGO	LADO	REF. ORIGINAL	EMB.
PL6066.01.62	Direito	23752741	01
PL6066.02.62	Esquerdo	23752746	01

PL 6004

Farol auxiliar foco duplo
Com soquete tipo original
Aplicação caminhões FH13



CÓDIGO	LADO	Não acompanha lâmpada	
		REF. ORIGINAL	EMB.
PL6004.01.02	Direito	21297917	01
PL6004.02.02	Esquerdo	21297918	01

REPOSIÇÃO

Lente em vidro



CÓDIGO	LADO	REF. ORIGINAL	EMB.
PL6005.01.02	Direito	21120482	01
PL6005.02.02	Esquerdo	21118550	01

Moldura para farol auxiliar



CÓDIGO	LADO	EMB.
PL6005.01.16	Direito	02
PL6005.02.16	Esquerdo	02

PL 6035

Lente em vidro para farol principal
Aplicação farol principal caminhões VL FH12 FM12



CÓDIGO	LADO	EMB.
PL6035.01.22	Direito	01
PL6035.02.22	Esquerdo	01

PL 6044

Farol principal
Com conector tipo original e lente em vidro
Aplicação caminhões VM 2017/2023



CÓDIGO	LADO	REF. ORIGINAL	EMB.
PL6044.01.02	Direito	20537267	01
PL6044.02.02	Esquerdo	20537266	01



Conector tipo original

REPOSIÇÃO

Moldura para farol



CÓDIGO	LADO	REF. ORIGINAL	EMB.
PL6045.01.17	Direito	20537293	01
PL6045.02.17	Esquerdo	20537290	01

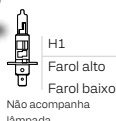

H1
Farol alto
Farol baixo
Não acompanha lâmpada

PL 6082

Farol teto LED
Adaptação
Aplicação caminhões VL



LED 24V

CÓDIGO	LADO	REF. ORIGINAL	EMB.
PL6082.01.22	Direito	84055744	01
PL6082.02.22	Esquerdo		01

PL 0700

Lanterna direcional
Aplicação VL NL 10 / 12



CÓDIGO	LADO	EMB.
PL0700.01.06	Direito	04
REF. ORIGINAL	V08121102 ou 812 1102	
PL0700.02.06	Esquerdo	04
REF. ORIGINAL	V08121103 ou 812 1103	

REPOSIÇÃO

Lente



CÓDIGO	LADO	EMB.
PL0701.01.06	Direito	05
REF. ORIGINAL	9003 ou 130 7454	
PL0701.02.06	Esquerdo	05
REF. ORIGINAL	9002 ou 13 7453	

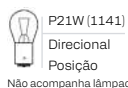

P21W (1141)
Direcional
Posição
Não acompanha lâmpada

PL 1700

Lanterna direcional
Aplicação VL NH - 12



CÓDIGO	LADO	EMB.
PL1700.01.01	Direito	02
REF. ORIGINAL	8 129 383	
PL1700.02.01	Esquerdo	02
REF. ORIGINAL	8 129 384	

Com cúpula



CÓDIGO	LADO	EMB.
PL1700.03.02	Direito	02
REF. ORIGINAL	205 21 163	
PL1700.04.02	Esquerdo	02
REF. ORIGINAL	205 21 164	

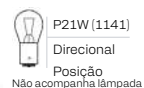

P21W (1141)
Direcional
Posição
Não acompanha lâmpada

PL 0708

Lanterna direcional
Com lente em acrílico e sem soquete
Aplicação VL VM



CÓDIGO	LADO	REF. ORIGINAL	EMB.
PL0708.21.22	Direito	2053 7295	02
PL0708.22.22	Esquerdo	2053 7294	02



P21W
Direcional
Não acompanha lâmpada

REPOSIÇÃO

Soquete em nylon tipo VL



CÓDIGO	EMB.
PL9921.17.97	10

PL 1708

Lanterna direcional
com cúpula e lente em acrílico
Aplicação FH 12 (96 a 2004)

Sem soquete



CÓDIGO	REF. ORIGINAL	EMB.
PL1708.00.22	398 1668	02



Vista parte traseira

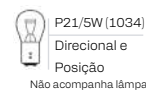

P21/5W (1034)
Direcional e
Posição
Não acompanha lâmpada

REPOSIÇÃO

Soquete com 2 polos em nylon



CÓDIGO	EMB.
PL9919.37.94	10

PL 0862

Lanterna direcional
Com lente em acrílico
Aplicação FH NEW

LED 24V



CÓDIGO	LADO	REF. ORIGINAL	EMB.
PL0862.41.42	Direito	84389663	01
PL0862.42.42	Esquerdo	24189495	01

Conector tipo original

PL 1710

Lanterna direcional
Com lente em acrílico e sem soquete
Aplicação FH 12 (96 a 2004)



REPOSIÇÃO

Soquete com 1 polo em nylon tipo VL



CÓDIGO	REF. ORIGINAL	EMB.
PL1710.00.22	398 1666	02



PY21W (1056)
Direcional
Não acompanha lâmpada

CÓDIGO	EMB.
PL9932.17.94	10

PL 0714

Lanterna direcional 12 LEDs
Com conector e lente em acrílico
Aplicação VL e universal

LED 24V



COM LED AMARELO

CÓDIGO	LADO	REF. ORIGINAL	EMB.
PL0714.21.62	Direito	82355678	04
PL0714.22.62	Esquerdo	82114500	04



PL 0744

Lanterna direcional LED
Com conector e lente em acrílico
Aplicação VL FH

LED 24V



COM LED AMARELO

CÓDIGO	LADO	REF. ORIGINAL	EMB.
PL0744.33.62	Direito	82151205	01
PL0744.34.62	Esquerdo	82151157	01



REPOSIÇÃO

Chicote com conector 2 vias para lanternas LED



CÓDIGO	EMB.
PL9998.17.97	10

PL 0704

Lanterna direcional
Aplicação ônibus, caminhões VL e universal

Com LED LED BIVOLT



CÓDIGO	EMB.
PL0704.00.41	10

Vista parte traseira

Sem soquete



CÓDIGO	EMB.
PL0704.00.01	10

Vista parte traseira

Com luva e soquete



CÓDIGO	EMB.
PL0704.41.01	10

Vista parte traseira



T4W
Direcional
Não acompanha lâmpada

REF. ORIGINAL 37201043 ou 8121815

PL 0740

Lanterna direcional
Aplicação VM220, VM270 e VM330



REPOSIÇÃO

Soquete com 1 polo em nylon tipo VL



CÓDIGO	EMB.
PL0740.00.21	10

REF. ORIGINAL 21341202

CÓDIGO	EMB.
PL0740.00.22	10

CÓDIGO	EMB.
PL9932.17.94	10

PL 1704

Lanterna direcional
Sem soquete
Aplicação VL FH 12



P21W
Direcional
Não acompanha lâmpada

CÓDIGO	LADO	EMB.
PL1704.01.01	Direito	10
PL1704.02.01	Esquerdo	10

REPOSIÇÃO

Suporte em ABS



CÓDIGO	LADO	EMB.
PL1706.01.17	Direito	20
REF. ORIGINAL	2082 6231 ou 2042 5419	
PL1706.02.17	Esquerdo	20
REF. ORIGINAL	2082 6227 ou 2042 5418	

Soquete em Nylon tipo VL



CÓDIGO	EMB.
PL9920.17.97	20

PL 0706

Lanterna delimitadora
Aplicação VL FH / NH - 12



Sem soquete

CÓDIGO	REF. ORIGINAL	EMB.
PL0706.00.02	8 141 013	06

Com soquete

CÓDIGO	EMB.
PL0706.41.02	06

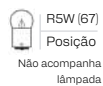

REPOSIÇÃO

Chicote com soquete de 1 polo



CÓDIGO	EMB.
PL9911.17.97	10

PL 0746

Lanterna delimitadora LED
Com conector
Aplicação FH e FM

LED 24V



REPOSIÇÃO

Chicote com conector 2 vias para lanternas LED



CÓDIGO	REF. ORIGINAL	EMB.
PL0746.24.61	20789440	05

CÓDIGO	EMB.
PL9998.17.97	10

PL 0486

Lanterna delimitadora LED
Com conector e lente em acrílico
Aplicação VL

LED BIVOLT



REPOSIÇÃO

Chicote com conector 2 vias para lanternas LED



CÓDIGO	EMB.
PL0486.00.62	10

REF. ORIGINAL 82116545

CÓDIGO	EMB.
PL9998.17.97	10

PL 0710

Lanterna delimitadora
Com soquete e lente em acrílico
Aplicação VL VM



CÓDIGO	EMB.
PL0710.00.22	02

REF. ORIGINAL 20745225 ou 20495172



PL 0770

Lanterna delimitadora LED
Com conector e lente em acrílico
Aplicação VL FH e FM

LED BIVOLT



CÓDIGO	EMB.
PL0770.00.62	02

REF. ORIGINAL 21214534



PL 0768

Lanterna LED de teto com moldura
Aplicação VL FH4/FH16 a partir de 2015

LED 24V



CÓDIGO	LADO	REF. ORIGINAL	EMB.
PL0768.41.62	Direita	82278938	02
PL0768.42.62	Esquerda	82278930	02

PL 0766

Lanterna delimitadora LED
Aplicação VL FH16 a partir de 2015

LED 24V



Lado direito

CÓDIGO	EMB.
PL0766.41.62	02

REF. ORIGINAL 82349221



Central

CÓDIGO	EMB.
PL0766.00.62	02

REF. ORIGINAL 82348508



Lado esquerdo

CÓDIGO	EMB.
PL0766.42.62	02

REF. ORIGINAL 82349220

PL 0752

Lanterna delimitadora
Com lente em acrílico
Aplicação VL FH

Para lâmpadas



Com cabos e LED 24V



Lado direito

CÓDIGO	EMB.
PL0752.35.22	10



Com base reta

CÓDIGO	EMB.
PL0752.15.22	10



Lado esquerdo

CÓDIGO	EMB.
PL0752.36.22	10



Lado direito

CÓDIGO	EMB.
PL0752.35.62	10



Com base reta

CÓDIGO	EMB.
PL0752.15.62	10

REF. ORIGINAL 20425016



Lado esquerdo

CÓDIGO	EMB.
PL0752.36.62	10

REPOSIÇÃO

Lente em acrílico



CÓDIGO	EMB.
PL0753.00.22	10

PL 0702

Lanterna traseira
Aplicação VL NL 10 / 12



REPOSIÇÃO

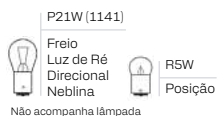

CÓDIGO	DESCRIÇÃO	LADO	REF. ORIGINAL	EMB.
PL0702.13.09	Sem vigia	Direito	01620477	01
PL0702.14.09	Com vigia	Esquerdo	01620476	01

Lente



CÓDIGO	EMB.
PL0703.00.09	15
REF. ORIGINAL	016204480

PL 0728 LED

Lanterna traseira LED
Aplicação VL FH

LED BIVOLT



CÓDIGO	DESCRIÇÃO	LADO	EMB.
PL0728.21.49	Com 30 LEDs - Sem vigia	Direito	01
PL0728.22.49	Com 32 LEDs - Com vigia	Esquerdo	01

PL 0728

Lanterna traseira
Aplicação VL FH



CÓDIGO	DESCRIÇÃO	LADO	REF. ORIGINAL	EMB.
PL0728.41.09	Sem vigia	Direito	20507624 ou 1508181	01
PL0728.42.09	Com vigia	Esquerdo	20507623 ou 1508180	01

Com cabos para adaptação



CÓDIGO	DESCRIÇÃO	LADO	EMB.
PL0728.13.09	Sem vigia	Direito	01
PL0728.14.09	Com vigia	Esquerdo	01

Lente



CÓDIGO	REF. ORIGINAL	EMB.
PL0729.00.09	20425732 ou 1412392	10

REPOSIÇÃO

Chicote 7 vias fêmea
com 20cm de cabos



CÓDIGO	EMB.
PL9947.39.00	10

PL 1702

Lanterna traseira
Com cabos. Aplicação VL FH / NH / FM / 12



CÓDIGO	DESCRIÇÃO	LADO	REF. ORIGINAL	EMB.
PL1702.13.09	Sem vigia	Direito	398 1461 ou 819 1747	03
PL1702.14.09	Com vigia	Esquerdo	398 1460 ou 819 1748	03

Lente



CÓDIGO	EMB.
PL1615.00.09	15

REPOSIÇÃO

Chicote 7 vias fêmea
com 20cm de cabos



CÓDIGO	EMB.
PL9947.39.00	10

PL 1550

Lanterna traseira LED
Com conector
Aplicação VL VM

LED 24V



CÓDIGO	DESCRIÇÃO	LADO	REF. ORIGINAL	EMB.
PL1550.01.47	Sem vigia	Direito	84441760	01
PL1550.02.47	Com vigia	Esquerdo	82483073	01

Lente



CÓDIGO	REF. ORIGINAL	EMB.
PL1551.00.07	84122332	06

REPOSIÇÃO

Chicote 7 vias fêmea
com 20cm de cabos



CÓDIGO	EMB.
PL9947.39.00	10

PL 1582

Lanterna traseira LED
Com conector
Aplicação VL FH New

LED 24V



Sem sirene de ré

CÓDIGO	DESCRIÇÃO	LADO	REF. ORIGINAL	EMB.
PL1582.01.67	Sem vigia	Direito	82849894	01
PL1582.02.67	Com vigia	Esquerdo	84195505	01

Com sirene de ré

CÓDIGO	DESCRIÇÃO	LADO	EMB.
PL1582.31.67	Sem vigia	Direito	01

REPOSIÇÃO

Chicote 7 vias fêmea
com 20cm de cabos



CÓDIGO	EMB.
PL9947.39.00	10

PL 0450

Lanterna direcional
Aplicação MB 718 / 912 / 914 e universal



CÓDIGO	REF. ORIGINAL	EMB.
PL0450.00.01	688 820 70 56	10



CÓDIGO	EMB.
PL0450.00.02	10

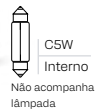

REPOSIÇÃO

Lente para lanterna direcional



CÓDIGO	EMB.
PL0451.00.01	20

REF. ORIGINAL 000 820 00 56



CÓDIGO	EMB.
PL0451.00.02	20

PL 0704

Lanterna direcional
Aplicação ônibus, caminhões VL e universal

Com LED **LED BIVOLT**



CÓDIGO	EMB.
PL0704.00.41	10



Vista parte traseira

Sem soquete



CÓDIGO	EMB.
PL0704.00.01	10



Vista parte traseira

Com luva e soquete



CÓDIGO	EMB.
PL0704.41.01	10



Vista parte traseira



PL 1310

Lanterna delimitadora com retrorrefletor
Sem soquete
Aplicação ônibus



Vista lateral



CÓDIGO	REF. ORIGINAL	EMB.
PL1310.00.01	26200678-6	10

PL 1314

Lanterna direcional e posição
Com lente em acrílico
Aplicação Ford 1119 e 816 e ônibus



Sem soquete



Vista parte lateral

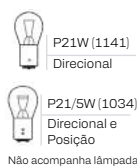

CÓDIGO	REF. ORIGINAL	EMB.
PL1314.00.21	EC45 13B376 AD (Direito) EC45 13B377 AD (Esquerdo)	10

REPOSIÇÃO

Soquete com 1 polo



REPOSIÇÃO	EMB.
PL9900.17.94	10

Soquete com 2 polos



REPOSIÇÃO	EMB.
PL9901.37.94	10

Chicote 2 vias



REPOSIÇÃO	EMB.
PL9950.17.00	10

Chicote 3 vias



REPOSIÇÃO	EMB.
PL9951.37.00	10

PL 1308

Lanterna delimitadora LED
Com retrorrefletor e lente acrílica
Aplicação ônibus Busscar, Neobus, Ciferal, Caio, Metalbus, Unibus e Marcopolo

LED BIVOLT

Com cabos para adaptação



Vista parte traseira

CÓDIGO	EMB.
PL1308.13.61	10

Com conector tipo original



Vista parte traseira

CÓDIGO	EMB.
PL1308.00.61	10



COM LED AMARELO



Vista parte traseira

CÓDIGO	EMB.
PL1308.51.62	10

REPOSIÇÃO

Chicote universal
Com conector ultra seal 2 vias



CÓDIGO	EMB.
PL9946.17.00	10

Com conector ultra seal 2 vias e conector Faston



CÓDIGO	EMB.
PL9946.41.00	10

PL 0572

Lanterna delimitadora
Aplicação ônibus e caminhões VW



RSW (67)
Posição
Não acompanha lâmpada

Com soquete para adaptação

Sem soquete tipo original



CÓDIGO EMB.
PL0572.41.01 10
REF. ORIGINAL 1A8 508 910 6

CÓDIGO EMB.
PL0572.00.01 10

CÓDIGO EMB.
PL0573.00.01 20
REF. ORIGINAL TAC 949 101

PL 0554

Lanterna delimitadora
Aplicação ônibus e caminhões VW



RSW (67)
Posição
Não acompanha lâmpada



CÓDIGO EMB.
PL0554.00.02 15
REF. ORIGINAL 2TA 945 05 1B

CÓDIGO EMB.
PL0554.00.01 15

CÓDIGO EMB.
PL0555.00.02 15
REF. ORIGINAL 2TA 945 425

PL 1340

Lanterna delimitadora
Com soquete interno



CÓDIGO EMB.
PL1340.41.02 10
REF. ORIGINAL 10201283-0

CÓDIGO EMB.
PL1340.41.03 10
REF. ORIGINAL 10201284-6

RSW (67)
Posição
Não acompanha lâmpada

PL 1427

Refletivo traseiro
Com lente em acrílico
Aplicação ônibus, MB Accelo, Sprinter e universal

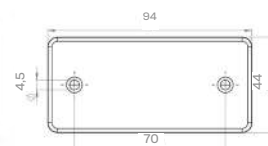

CÓDIGO REF. ORIGINAL EMB.
PL1427.00.21 AO 008 262 240 30

PL 0760

Lanterna com 10 LEDs
Com lente em acrílico para suporte traseiro aplicação universal



1 polo



1 polo



2 polos

CÓDIGO EMB.
PL0760.00.61 01

CÓDIGO EMB.
PL0760.00.62 01

CÓDIGO EMB.
PL0760.00.63 01

PL 0762

Lanterna com 10 LEDs
Com lente em acrílico para suporte traseiro aplicação universal



1 polo



1 polo



2 polos

CÓDIGO EMB.
PL0762.00.61 01

CÓDIGO EMB.
PL0762.00.62 01

CÓDIGO EMB.
PL0762.00.63 01

PL 0526

Lanterna universal
e aplicação em suportes traseiros



CÓDIGO EMB.
PL0526.00.01 10
REF. ORIGINAL 210102062

CÓDIGO EMB.
PL0526.00.02 10

CÓDIGO EMB.
PL0526.00.03 10

P21W (1141)
Freio Luz de ré Direcional

P21/5W (1034)
Freio e Posição Direcional e Posição
Não acompanha lâmpada

REPOSIÇÃO

Soquete com 1 polo



CÓDIGO EMB.
PL9900.17.94 10

Soquete com 2 polos



CÓDIGO EMB.
PL9901.37.94 10

Chicote 2 vias



CÓDIGO EMB.
PL9950.17.00 10

Chicote 3 vias



CÓDIGO EMB.
PL9951.37.00 10

PL 0756

Lanterna com lente lisa
aplicação ônibus e implementos



CÓDIGO EMB.
PL0756.23.01 10
REF. ORIGINAL 213000113



CÓDIGO EMB.
PL0756.23.02 10



CÓDIGO EMB.
PL0756.23.03 10
REF. ORIGINAL 213000112



CÓDIGO EMB.
PL0756.23.04 10

PL 0758

Lanterna com retrorefletor
aplicação ônibus e implementos



CÓDIGO EMB.
PL0758.00.07 10
REF. ORIGINAL 213000114



CÓDIGO EMB.
PL0758.00.08 10

REPOSIÇÃO

Soquete com 1 polo



CÓDIGO EMB.
PL9900.17.94 10

Soquete com 2 polos



CÓDIGO EMB.
PL9901.37.94 10

Chicote 2 vias



CÓDIGO EMB.
PL9950.17.00 10

Chicote 3 vias



CÓDIGO EMB.
PL9951.37.00 10



P21W (1141)
Freio
Luz de ré
Direcional



P21/SW (1034)
Freio e Posição
Direcional e Posição
Não acompanha lâmpada

PL 1354

Lanterna traseira com fixação frontal
aplicação ônibus e implementos



CÓDIGO EMB.
PL1354.00.01 10
REF. ORIGINAL 6233239M91



CÓDIGO EMB.
PL1354.00.02 10



CÓDIGO EMB.
PL1354.00.03 10
REF. ORIGINAL 6233240M91

PL 0582

Lanterna com lente lisa
Fixação frontal
aplicação ônibus e implementos



CÓDIGO EMB.
PL0582.00.01 10
REF. ORIGINAL 92210025001



CÓDIGO EMB.
PL0582.00.02 10
REF. ORIGINAL 92210026001



CÓDIGO EMB.
PL0582.00.23 10
REF. ORIGINAL 92210024001

REPOSIÇÃO

Soquete com 1 polo



CÓDIGO EMB.
PL9900.17.94 10

Soquete com 2 polos



CÓDIGO EMB.
PL9901.37.94 10

Chicote 2 vias



CÓDIGO EMB.
PL9950.17.00 10

Chicote 3 vias



CÓDIGO EMB.
PL9951.37.00 10



P21W (1141)
Freio
Luz de ré
Direcional



P21/SW (1034)
Freio e Posição
Direcional e Posição
Não acompanha lâmpada

PL 0523

Refletivo "olho de gato" 80mm
Com parafuso
Lente em acrílico



CÓDIGO EMB.
PL0523.00.23 15



CÓDIGO EMB.
PL0523.00.21 15



Vista parte traseira

PL 1527

Refletivo "olho de gato" 60mm
Lente em acrílico



Com parafuso



CÓDIGO EMB.
PL1527.00.21 30
REF. ORIGINAL 693 544 00 05



CÓDIGO EMB.
PL1527.00.23 30

Com furo central



CÓDIGO EMB.
PL1527.21.21 30



CÓDIGO EMB.
PL1527.21.23 30



Vista parte traseira



Vista parte traseira

PL 7046

Farol principal

Aplicação Ford F-1000 | F-4000



Vista parte traseira

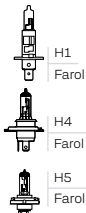

H1
Farol

H4
Farol

H5
Farol



T4W (69)
Posição

Não acompanha lâmpada

CÓDIGO	LADO	REF. ORIGINAL	EMB.
PL7046.01.22	Direito	85TU13005J	01
PL7046.02.22	Esquerdo	85TU13005J	01

PL 0422

Lanterna traseira

Aplicação pick-up Chevrolet A / G / D-20 (86 em diante)



P21W (1141)
Luz de ré
Direcional



P21/5W (1034)
Freio e Posição
Não acompanha lâmpada

REPOSIÇÃO

Lente



CÓDIGO	LADO	EMB.
PL0423.01.09	Direito	20
REF. ORIGINAL	94 649 305	
PL0423.02.09	Esquerdo	20
REF. ORIGINAL	94 649 304	

CÓDIGO	LADO	REF. ORIGINAL	EMB.
PL0422.01.09	Direito	94 632 188	06
PL0422.02.09	Esquerdo	94 632 187	06

PL 0402

Lanterna traseira com lente em acrílico

Aplicação pick-up F1000 (92 em diante)

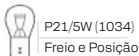

P21/5W (1034)
Freio e Posição

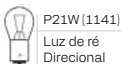

P21W (1141)
Luz de ré
Direcional
Não acompanha lâmpada

CÓDIGO	LADO	REF. ORIGINAL	EMB.
PL0402.01.29	Direito	ZAC 945096	01
PL0402.02.29	Esquerdo	ZAC 945095	01

PL 0424

Lanterna direcional

Aplicação Opala / Caravan / pick-up A / G / D-20 - 40 84 a 91



CÓDIGO	LADO	EMB.
PL0424.01.01	Direito	08
REF. ORIGINAL	94 642 843	
PL0424.02.01	Esquerdo	08
REF. ORIGINAL	94 642 844	

CÓDIGO	LADO	EMB.
PL0424.03.02	Direito	08
PL0424.04.02	Esquerdo	08

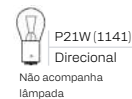

P21W (1141)
Direcional
Não acompanha lâmpada

PL 0680

Lanterna direcional

Aplicação F1000 e F4000 (1992 a 1997)



P21W (1141)
Direcional

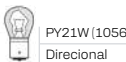

PY21W (1056)
Direcional
Não acompanha lâmpada

CÓDIGO	LADO	EMB.	CÓDIGO	LADO	EMB.
PL0680.01.01	Direito	02	PL0680.01.02	Direito	02
PL0680.02.01	Esquerdo	02	PL0680.02.02	Esquerdo	02

PL 0488

Lanterna direcional com lente em acrílico

Aplicação MB Sprinter 1995 a 2012



PY21W (1056)
Direcional
Não acompanha lâmpada

CÓDIGO	LADO	REF. ORIGINAL	EMB.
PL0488.01.22	Direito	901 820 02 21	02
PL0488.02.22	Esquerdo	901 820 01 21	02

PL 1006

Lanterna traseira sem soquete
Com lente em acrílico
Aplicação Mitsubishi L200 2007 a 2015



Vista parte traseira

P21W (1141)
Luz de ré
Direcional

P21/SW (1034)
Freio e Posição
Não acompanha lâmpada

CÓDIGO	LADO	REF. ORIGINAL	EMB.
PL1006.01.29	Direito	8330A010	01
PL1006.02.29	Esquerdo	8330A009	01

PL 1020

Lanterna traseira sem soquete
Com lente em acrílico
Aplicação Frontier a partir de 2016



Vista parte traseira

P21W (1141)
Luz de ré

P21/SW (1034)
Freio e Posição

PY21W (1056)
Direcional
Não acompanha lâmpada

CÓDIGO	LADO	REF. ORIGINAL	EMB.
PL1020.01.27	Direito	26550-4AJ04	01
PL1020.02.27	Esquerdo	26555-4AJ04	01

PL 1008

Lanterna traseira sem soquete
Com lente em acrílico
Aplicação Mitsubishi L200 2016 a 2018



Vista parte traseira

P21W (1141)
Luz de ré

P21/SW (1034)
Freio e Posição

PY21W (1056)
Direcional
Não acompanha lâmpada

CÓDIGO	LADO	REF. ORIGINAL	EMB.
PL1008.01.27	Direito	8330A944	01
PL1008.02.27	Esquerdo	8330A943	01

PL 1022

Lanterna traseira sem soquete
Com lente em acrílico
Aplicação Frontier 2007 a 2015



Vista parte traseira

PY21W (1056)
Direcional

P21/SW (1034)
Freio e Posição

W21W
Luz de ré
Não acompanha lâmpada

CÓDIGO	LADO	REF. ORIGINAL	EMB.
PL1022.01.27	Direito	26550-EA825	01
PL1022.02.27	Esquerdo	26555-EA825	01

PL 1012

Lanterna traseira sem soquete
Com lente em acrílico
Aplicação VW Amarok 2010 a 2016



Vista parte traseira

P21/SW (1034)
Freio e Posição

PY21W (1056)
Direcional

H21W
Luz de ré
Não acompanha lâmpada

CÓDIGO	LADO	REF. ORIGINAL	EMB.
PL1012.01.27	Direito	2H1945096B	01
PL1012.02.27	Esquerdo	2H2945095B	01

PL 0400

Lanterna traseira com chicote
Com luz de neblina e lente em acrílico
Aplicação Ducato, Peugeot Boxere e Citroen Jumper a partir de 2003



P21W (1141)
Luz de ré
Freio

PY21W (1056)
Direcional

RSW (67)
Posição
Não acompanha lâmpada

CÓDIGO	LADO	REF. ORIGINAL	EMB.
PL0400.31.27	Direito	1328427080	01
PL0400.32.27	Esquerdo	1328428080	01

PL 1000

Lanterna traseira sem soquete
Com lente em acrílico
Aplicação Hilux 2005 a 2011



Vista parte traseira

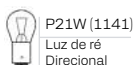

P21W (1141)
Luz de ré
Direcional



P21/5W (1034)
Freio e Posição

Não acompanha lâmpada

CÓDIGO	LADO	REF. ORIGINAL	EMB.
PL1000.01.29	Direito	815510K050	01
PL1000.02.29	Esquerdo	815610K050	01

PL 0440

Lanterna traseira
Aplicação Troller (até 2013)



P21W (1141)
Luz de ré



P21/5W (1034)
Freio e Posição



PY21W (1056)
Direcional

Não acompanha lâmpada

CÓDIGO	DESCRIÇÃO	LADO	EMB.
PL0440.01.07	Sem vigia	Direito	06
PL0440.02.07	Com vigia	Esquerdo	06

REPOSIÇÃO

Lente



CÓDIGO	EMB.
PL0441.00.07	30

PL 1002

Lanterna traseira sem soquete
Com lente em acrílico
Aplicação Hilux 2012 a 2015



Vista parte traseira



P21W (1141)
Luz de ré



P21/5W (1034)
Freio e Posição



PY21W (1056)
Direcional

Não acompanha lâmpada

CÓDIGO	LADO	REF. ORIGINAL	EMB.
PL1002.01.27	Direito	815510K180	01
PL1002.02.27	Esquerdo	815510K190	01

PL 0410

Lanterna direcional
Com 2 faces e 2 polos
Aplicação Toyota Bandeirante



P21W (1141)
Direcional

Não acompanha lâmpada

CÓDIGO	LADO	REF. ORIGINAL	EMB.
PL0410.37.01	Direito	81 510 98 002	15
PL0410.38.01	Esquerdo	81 520 98 002	15

REPOSIÇÃO

Lente



CÓDIGO	EMB.
PL0409.00.01	20
REF. ORIGINAL	001 822 55 10

PL 1004

Lanterna traseira sem soquete
Com lente em acrílico
Aplicação Hilux a partir de 2016



Vista parte traseira



P21W (1141)
Luz de ré



P21/5W (1034)
Freio e Posição



PY21W (1056)
Direcional

Não acompanha lâmpada

CÓDIGO	LADO	REF. ORIGINAL	EMB.
PL1004.01.27	Direito	815510K260	01
PL1004.02.27	Esquerdo	815610K260	01

PL 0516

Lanterna traseira
Aplicação Toyota Bandeirante



P21W (1141)
Luz de ré
Direcional



P21/5W (1034)
Freio e Posição

Não acompanha lâmpada

CÓDIGO	LADO	REF. ORIGINAL	EMB.
PL0516.21.09	Sem vigia Direito	81 510 98 004	08
PL0516.22.09	Com vigia Esquerdo	81 551 98 003	08

REPOSIÇÃO

Lente



CÓDIGO	EMB.
PL0517.21.09	20

PL 0810

Lanterna traseira e lateral LED
Modelo americano com 12 LED's

Direcional



CÓDIGO TENSÃO EMB.
PL0810.00.41 LED BIVOLT 10

Luz de ré



CÓDIGO TENSÃO EMB.
PL0810.00.42 LED BIVOLT 10

Freio e posição



CÓDIGO TENSÃO EMB.
PL0810.00.43 LED BIVOLT 10

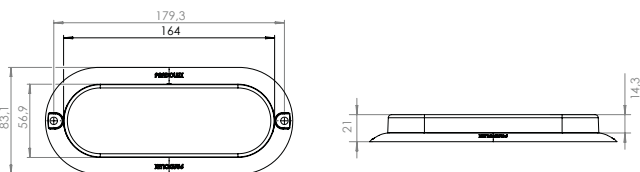

Freio, posição e direcional



CÓDIGO TENSÃO EMB.
PL0810.00.40 LED BIVOLT 10

Freio, posição e direcional



CÓDIGO TENSÃO EMB.
PL0810.00.45 LED BIVOLT 10

Freio, posição e luz de ré



CÓDIGO TENSÃO EMB.
PL0810.00.47 LED BIVOLT 10

Freio, posição, direcional e luz de ré



CÓDIGO TENSÃO EMB.
PL0810.00.49 LED BIVOLT 10

PL 0802

Lanterna traseira blindada LED 3 funções
Com 8 LEDs e lente em acrílico
Função direcional, posição e freio.
Aplicação universal



LED BIVOLT



CÓDIGO EMB.
PL0802.00.67 10

PL 0804

Lanterna traseira blindada LED 4 funções
Com 8 LEDs e lente em acrílico
Função direcional, luz de ré, posição e freio
Aplicação universal



LED BIVOLT



CÓDIGO EMB.
PL0804.00.67 10

PL 0502

Lanterna traseira com base plástica



Vista parte traseira



P21W (1141)
Direcional



P21/SW (1034)
Freio e Posição
Não acompanha lâmpada



CÓDIGO EMB.
PL0503.00.05 10

CÓDIGO EMB.
PL0502.00.05 10

PL 0542

Lanterna traseira universal para para-choque



REPOSIÇÃO

Lente



CÓDIGO EMB.
PL0543.00.05 10

CÓDIGO EMB.
PL0542.00.05 15



P21W (1141)
Direcional

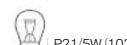

P21/SW (1034)
Freio e Posição
Não acompanha lâmpada

PL 0506

Lanterna universal



93mm



Vista parte traseira



CÓDIGO EMB.
PL0507.00.01 20

RSW (67)
Posição
Não acompanha lâmpada

CÓDIGO EMB.
PL0506.00.01 20

PL 0458

Lanterna posição com haste universal

Com lente arredondada



CÓDIGO EMB.
PL0458.29.01 15

Com lente borda reta



CÓDIGO EMB.
PL0458.00.01 15

RSW (67)
Posição
Não acompanha lâmpada

REPOSIÇÃO

Lente borda arredondada



CÓDIGO EMB.
PL0599.29.01 20

Lente borda reta

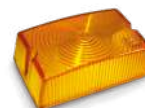

CÓDIGO EMB.
PL0599.00.01 30

PL 0600

Lanterna lateral
Aplicação Facchini

Com lente borda arredondada



CÓDIGO	EMB.	CÓDIGO	EMB.	CÓDIGO	EMB.
PL0600.29.01	20	PL0600.29.02	20	PL0600.29.03	20

RSW (67)
Posição
Não acompanha lâmpada

Com LED e lente borda arredondada

LED BIVOLT



CÓDIGO	EMB.	CÓDIGO	EMB.	CÓDIGO	EMB.
PL0600.29.41	10	PL0600.29.42	10	PL0600.29.43	10

PL 0602

Com interruptor e lente borda arredondada



RSW (67)
Posição
Não acompanha lâmpada

CÓDIGO	EMB.
PL0600.20.02	20

Lanterna traseira conjunto com 4 lentes



CÓDIGO	EMB.
PL0602.71.09	08

RSW (67)
Posição
Não acompanha lâmpada

P21W (1141)
Freio
Luz de ré
Direcional

REPOSIÇÃO

Lente borda arredondada



CÓDIGO	EMB.	CÓDIGO	EMB.	CÓDIGO	EMB.
PL0599.29.01	20	PL0599.29.02	20	PL0599.29.03	20

PL 0650

Lanterna Ecoline universal para para-choque em pedestal com suporte cromado

Com lente Lisa



CÓDIGO	EMB.	CÓDIGO	EMB.
PL0650.00.01	15	PL0650.00.03	15

P21W (1141)
Posição
Não acompanha lâmpada

Com lente bojuda



CÓDIGO	EMB.	CÓDIGO	EMB.
PL0650.21.01	10	PL0650.21.03	10

REPOSIÇÃO

Lente lisa



CÓDIGO	EMB.	CÓDIGO	EMB.	CÓDIGO	EMB.
PL0525.00.01	20	PL0525.00.02	20	PL0525.00.03	20

Lente bojuda



CÓDIGO	EMB.	CÓDIGO	EMB.
PL0525.21.01	20	PL0525.21.03	20

Aro para lanterna



CÓDIGO	EMB.
PL0650.84.16	20

Conjunto com lanternas Ecoline com lente lisa



CÓDIGO	COR	EMB.
PL0650.70.01	Amarelo	01
PL0650.70.03	Vermelho	01



CÓDIGO	COR	EMB.
PL0650.71.01	Amarelo	01
PL0650.71.03	Vermelho	01



CÓDIGO	COR	EMB.
PL0650.72.01	Amarelo	01
PL0650.72.03	Vermelho	01

Conjunto com lanternas Ecoline com lente bojuda



CÓDIGO	COR	EMB.
PL0650.53.01	Amarelo	01
PL0650.53.03	Vermelho	01



CÓDIGO	COR	EMB.
PL0650.54.01	Amarelo	01
PL0650.54.03	Vermelho	01



CÓDIGO	COR	EMB.
PL0650.52.01	Amarelo	01
PL0650.52.03	Vermelho	01

PL 0512

Lanterna lateral universal
Com grade preta e soquete embutido



CÓDIGO	EMB.	CÓDIGO	EMB.	CÓDIGO	EMB.	CÓDIGO	EMB.
PL0512.87.01	10	PL0512.87.02	10	PL0512.87.03	10	PL0512.87.12	10

RSW (67)
Posição
Não acompanha
lâmpada

REPOSIÇÃO

Lente



CÓDIGO	COR	EMB.
PL0593.00.01	Amarelo	25
PL0593.00.02	Cristal	25
PL0593.00.03	Vermelho	25
PL0593.00.12	Verde	25

PL 0404

Lanterna para para-choque



CÓDIGO	EMB.
PL0404.60.03	15

REPOSIÇÃO

Lente



CÓDIGO	COR	EMB.
PL0405.00.01	Amarelo	20
PL0405.00.03	Vermelho	20

PL 0452

Lanterna retangular
Aplicação Furgão

Com borda reta
para lâmpada



CÓDIGO	EMB.
PL0452.00.01	10

T4W (69)
Posição

Não acompanha
lâmpada



CÓDIGO	EMB.
PL0452.00.02	10



CÓDIGO	EMB.
PL0452.00.03	10

Com borda arredondada
e LED



CÓDIGO	EMB.
PL0452.29.41	10

LED BIVOLT



CÓDIGO	EMB.
PL0452.29.42	10



CÓDIGO	EMB.
PL0452.29.43	10

REPOSIÇÃO

Lente com borda reta



CÓDIGO	COR	EMB.
PL0453.00.01	Amarelo	10
PL0453.00.02	Cristal	10
PL0453.00.03	Vermelho	10

Nossa História, Nossa Luz.



PL 9900

Soquete com 1 polo
Aplicação universal



Para lâmpadas



P21W Freio
Luz de ré
Direcional



RSW
Posição

CÓDIGO EMB.
PL9900.17.94 10

PL 9901

Soquete com 2 polos
Aplicação universal



Para lâmpadas



P21/SW
Freio e Posição
P21/SW
Direcional e
Posição

CÓDIGO EMB.
PL9901.37.94 10

PL 9903

Chicote 3 vias
Aplicação lanterna Americana PL0200 e PL0204



CÓDIGO EMB.
PL9903.37.00 10

PL 9906

Chicote com soquete de 1 polo
Aplicação VW para lanternas PL0696 e PL0698



Para lâmpadas



WSW
Posição

CÓDIGO EMB.
PL9906.17.00 10

PL 9907

Chicote com conector
Aplicação MB para faróis PL6036



CÓDIGO EMB.
PL9907.00.00 10

PL 9909

Chicote 2 vias para
Aplicação lanterna Americana PL0202



CÓDIGO EMB.
PL9909.17.00 10

PL 9911

Chicote com soquete de 1 polo
Aplicação universal ônibus para lanternas PL0438 e PL0706



Para lâmpadas



P21W
Freio
Luz de ré
Direcional



RSW
Posição

CÓDIGO EMB.
PL9911.17.94 10

PL 9913

Soquete com 1 polo
Aplicação universal para lanternas PL0426, PL0442,
PL0470, PL0598



Para lâmpadas



T4W
Posição

CÓDIGO REF. ORIGINAL EMB.
PL9913.17.97 MB 345.544.01.93 VL 344-130 20

PL 9914

Soquete com 1 polo
Aplicação universal e VW para lanterna PL0598



Para lâmpadas



WSW
Posição

REPOSIÇÃO



Chicote com conector 2 vias
CÓDIGO EMB.
PL9994.17.97 10

CÓDIGO EMB.
PL9914.17.96 20

PL 9915

Soquete de 1 polo
Aplicação MB e universal para farol luz baixa



Para lâmpadas



H7
Farol

CÓDIGO EMB.
PL9915.37.97 10

PL 9916

Chicote com soquete de 1 polo
tipo cachimbo
Aplicação MB e universal para lanterna PL0520



Para lâmpadas



RSW
Posição



P21W
Freio
Luz de ré
Direcional

CÓDIGO EMB.
PL9916.17.94 10

PL 9917

Chicote com soquete de 2 polos
tipo cachimbo
Aplicação MB e universal para lanternas PL0466, PL0476
e PL0520



Para lâmpadas



P21/SW
Direcional e
Posição

CÓDIGO EMB.
PL9917.37.94 10

PL 9918

Soquete com 1 polo em nylon
Aplicação IV para lanternas PL0722, PL0732
e PL0738



Para lâmpadas



PY21W
Direcional

CÓDIGO EMB.
PL9918.17.96 10

PL 9919

Soquete com 2 polos em nylon
Aplicação VL para lanterna PL1708



Para lâmpadas



P21/SW
Direcional e
Posição

CÓDIGO EMB.
PL9919.37.94 10

PL 9920

Soquete com 1 polo em nylon
Aplicação VL para lanterna PL1704



Para lâmpadas



P21W
Direcional e
Posição

CÓDIGO EMB.
PL9920.17.97 20

PL 9921

Soquete com 1 polo em nylon
Aplicação VL para lanterna PL0708



Para lâmpadas



P21W
Direcional

CÓDIGO EMB.
PL9921.17.97 10

PL 9922

Soquete com 1 polo em nylon
Aplicação MB para lanternas PL0588 e PL0592



Para lâmpadas



CÓDIGO EMB.
PL9922.17.96 10

PL 9923

Soquete com 2 polos em Nylon



Para lâmpadas

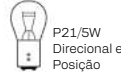

CÓDIGO EMB.
PL9923.37.97 10

PL 9924

Soquete com 1 polo em nylon
Aplicação VW para função posição da lanterna PL0896



Para lâmpadas



CÓDIGO EMB.
PL9924.17.96 20

REF. ORIGINAL VW 547 953 055-0

REPOSIÇÃO

Chicote com conector 2 vias



CÓDIGO EMB.
PL9996.17.97 10

PL 9925

Soquete em nylon
Aplicação MB para função farol luz alta



Para lâmpadas



CÓDIGO EMB.
PL9925.37.97 10

PL 9926

Soquete com 1 polo em nylon
Aplicação VW para função direcional da lanterna PL0896



Para lâmpadas



CÓDIGO REF. ORIGINAL EMB.
PL9926.17.94 GM 90 444 711 10

PL 9928

Soquete com 1 polo em nylon
Aplicação VW para função posição das lanternas PL0730 e PL0986



Para lâmpadas



CÓDIGO REF. ORIGINAL EMB.
PL9928.17.94 90 443 393 20

PL 9929

Soquete com 1 polo em nylon
Aplicação SC para faróis PL6112 e PL6114



Para lâmpadas



CÓDIGO EMB.
PL9929.17.97 10

PL 9930

Soquete com 1 polo em nylon
Aplicação VW para função direcional da lanterna PL0986



Para lâmpadas



CÓDIGO EMB.
PL9930.17.97 10

PL 9931

Chicote com soquete 2 polos
Aplicação em lanternas PL0612



Para lâmpadas



CÓDIGO EMB.
PL9931.37.97 01

PL 9932

Soquete com 1 polo em nylon
Aplicação VL para lanternas PL0740 e PL1710



Para lâmpadas



CÓDIGO EMB.
PL9932.17.94 10

PL 9933

Soquete com 1 polo
Aplicação MB para lanternas PL0574



Para lâmpadas



CÓDIGO EMB.
PL9933.17.96 10

PL 9934

Soquete com 1 polo em nylon
Aplicação Ford para lanternas PL0494 e PL0496



Para lâmpadas



CÓDIGO EMB.
PL9934.17.95 10

PL 9935

Soquete com 2 polos
Aplicação MB para lanternas PL0574



Para lâmpadas

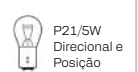

CÓDIGO EMB.
PL9935.37.96 10

PL 9936

Chicote com soquete de 1 polo tipo cachimbo e terminal
Aplicação Ford para lanterna PL0434



Para lâmpadas



CÓDIGO EMB.
PL9936.17.94 10

PL 9945

Chicote universal com conector ultra seal 5 vias macho
Aplicação universal



CÓDIGO EMB.
PL9945.00.00 10

PL 9946

Chicote universal com conector ultra seal 2 vias
Aplicação universal



Com conector faston

CÓDIGO EMB. CÓDIGO EMB.
PL9946.17.00 10 **PL9946.41.00** 10

PL 9947

Chicote 7 vias fêmea com 20cm de cabos
Aplicação lanternas PL0728, PL0916, PL1442, PL1550, PL1616, PL1618 e PL1702



CÓDIGO	REF. ORIGINAL	EMB.
PL9947.39.00	3963412	10

PL 9948

Chicote 2 vias com guarda pó para Faston 6,3mm
Aplicação lanternas laterais



CÓDIGO	EMB.
PL9948.17.00	10

PL 9950

Chicote 2 vias com guarda pó para Faston 6,3mm
Aplicação lanternas com módulos LEDs



CÓDIGO	EMB.
PL9950.17.00	10

PL 9951

Chicote 3 vias com guarda pó para Faston 6,3mm
Aplicação lanternas com módulos LEDs



CÓDIGO	EMB.
PL9951.37.00	10

PL 9952

Chicote completo
Aplicação lanterna PL0826



CÓDIGO	EMB.
PL9952.41.00	10

PL 9953

Chicote com conector ultra seal 5 vias e conector Faston 6,3mm
Aplicação universal



CÓDIGO	EMB.
PL9953.39.00	10

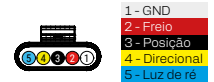

PL 9955

Soquetes com 1 polo
Aplicação SC para lanterna PL0478



CÓDIGO	EMB.
PL9955.17.00	10



PL 9956

Soquete em nylon
Aplicação MB para lanternas PL0348 e PL0498



CÓDIGO	EMB.
PL9956.17.97	10



PL 9958

Soquete 1 polo em nylon
Aplicação MB



CÓDIGO	EMB.
PL9958.17.00	10



PL 9974

Soquete 2 polos
Aplicação faróis Ford Cargo



CÓDIGO	EMB.
PL9974.37.97	10



PL 9954

Chicote com 4 soquetes e conector
Aplicação lanterna PL1446

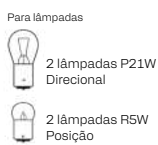

CÓDIGO	EMB.
PL9954.17.00	05

REF. ORIGINAL 1.732.515 - 1467007

PL 9975

Chicote com conector ultra seal 4 vias
Aplicação lanterna



CÓDIGO	EMB.
PL9975.00.00	10

PL 9976

Soquete 1 polo
Aplicação faróis MB / VW



CÓDIGO	EMB.
PL9976.17.97	10

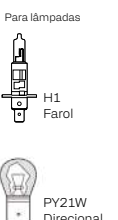

PL 9977

Chicote adaptador com conectores
Aplicação faróis PL7038



CÓDIGO	EMB.
PL9977.00.00	01

PL 9978

Soquete com 2 polos em nylon
Aplicação faróis PL7010



CÓDIGO	EMB.
PL9978.37.97	10



PL 9981

Chicote adaptador com conectores para PL0988
Aplicação em todos os anos



CÓDIGO	EMB.
PL9981.00.00	10

Não necessita alterar chicote original; Deixa o caminhão mais bonito e moderno; Montagem prática em menos de 5 minutos.

PL 9983

Chicote com conector 6 vias - Macho
Aplicação lanterna PL0482



CÓDIGO EMB.
PL9983.00.00 10

PL 9984

Chicote conector
Aplicação suporte traseiro PL2600 / PL1560



Lado esquerdo

CÓDIGO EMB.
PL9984.42.13 10

Lado direito

CÓDIGO EMB.
PL9984.41.12 10

PL 9985

Chicote com conector 6 vias - Fêmea
Aplicação lanterna PL0482

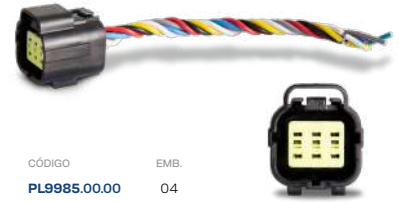

CÓDIGO EMB.
PL9985.00.00 04

PL 9986

Chicote com conector 7 vias
Aplicação lanterna PL0912



CÓDIGO EMB.
PL9986.00.97 10

PL 9987

Chicote completo para farol
Aplicação farol PL7028



CÓDIGO EMB.
PL9987.41.00 05

PL 9988

Chicote com conector 6 vias SC
Aplicação lanterna PL1544



CÓDIGO EMB.
PL9988.00.97 10

PL 9989

Chicote completo MB Actros
Aplicação farol PL7030



CÓDIGO EMB.
PL9989.41.00 10

PL 9990

Chicote com conector 8 vias DAF
Aplicação lanterna PL1620



CÓDIGO EMB.
PL9990.00.97 10

PL 9991

Chicote completo
Aplicação lanterna PL0828

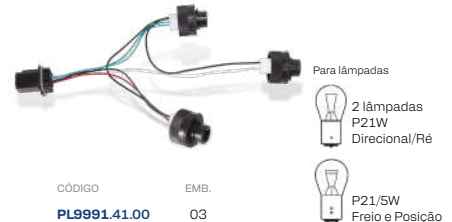

CÓDIGO EMB.
PL9991.41.00 03

PL 9994

Chicote com conector 2 vias
Aplicação lanterna PL0576



CÓDIGO EMB.
PL9994.17.97 10

PL 9995

Chicote com conector 3 vias
Aplicação lanterna PL0474



CÓDIGO EMB.
PL9995.37.97 10

PL 9996

Chicote com conector 2 vias
Aplicação lanternas PL0448, PL0518 e PL0896



CÓDIGO EMB.
PL9996.17.97 10

PL 9997

Chicote com conector ultra seal 3 vias
Aplicação lanterna PL0996



CÓDIGO EMB.
PL9994.37.97 10

PL 9998

Chicote com conector 2 vias
Aplicação lanternas PL1454, PL0486, PL0492, PL0714, PL0744, PL0746 e PL0750



CÓDIGO EMB.
PL9998.17.97 10

PL 9999

Chicote com conector 5 vias fêmea
Aplicação lanternas PL0716



CÓDIGO EMB.
PL9999.17.97 10

PL 9101

Cabo elétrico 1 via redondo
Bitola 0,75mm



CÓDIGO	COR	EMB.
PL9101.10.00	Branco	metro
PL9101.20.00	Vermelho	metro
PL9101.30.00	Verde	metro
PL9101.40.00	Azul	metro
PL9101.50.00	Amarelo	metro
PL9101.60.00	Marrom	metro
PL9101.70.00	Preto	metro

Obs.: Bobina com até 200m de comprimento.

PL 9102

Cabo elétrico 2 vias retangular
Bitola 0,75mm



CÓDIGO	BITOLA	EMB.
PL9102.00.00	0,75mm	metro

Obs.: Bobina com até 200m de comprimento.

PL 9103

Cabo elétrico redondo
Bitola 1mm



CÓDIGO	BITOLA	EMB.
PL9103.00.00	1mm	metro

Obs.: Bobina com até 200m de comprimento.

PL 9104

Cabo elétrico 2 vias redondo
Bitola 1mm



CÓDIGO	BITOLA	EMB.
PL9104.00.00	1mm	metro

Obs.: Bobina com até 200m de comprimento.

PL 9105

Cabo elétrico redondo
Bitola 1,5mm



CÓDIGO	BITOLA	EMB.
PL9105.00.00	1,5mm	metro

Obs.: Bobina com até 200m de comprimento.

PL 9106

Cabo elétrico 2 vias redondo
Bitola 1,5mm



CÓDIGO	BITOLA	EMB.
PL9106.00.00	1,5mm	metro

Obs.: Bobina com até 200m de comprimento.

PL 9107

Cabo elétrico 3 vias redondo



CÓDIGO	BITOLA	EMB.
PL9107.00.00	0,50mm	metro
PL9107.10.00	1,00mm	metro

Obs.: Bobina com até 200m de comprimento.

PL 9108

Cabo elétrico 5 vias redondo
Bitola 0,5mm



CÓDIGO	BITOLA	EMB.
PL9108.00.00	0,50mm	metro

Obs.: Bobina com até 200m de comprimento.

PL 9109

Cabo elétrico 7 vias redondo
Bitola 0,5mm



CÓDIGO	BITOLA	EMB.
PL9109.00.00	0,50mm	metro

Obs.: Bobina com até 200m de comprimento.

PL 9110

Cabo elétrico 2 vias retangular
Bitola 0,5mm



CÓDIGO	BITOLA	EMB.
PL9110.00.00	0,50mm	metro

Obs.: Bobina com até 200m de comprimento.

PL 9200

Terminal fêmea em latão



CÓDIGO	TAMANHO	EMB.
PL9200.00.00	6,3mm	01

Obs.: Embalagem com 50un.

PL 9201

Terminal macho em latão



CÓDIGO	TAMANHO	EMB.
PL9201.00.00	6,3mm	01

Obs.: Embalagem com 50un.

PL 9202

Capa para terminal fêmea



CÓDIGO	TAMANHO	EMB.
PL9202.00.00	6,3mm	01

Obs.: Embalagem com 50un.

PL 9203

Capa para terminal macho



CÓDIGO	TAMANHO	EMB.
PL9203.00.00	6,3mm	01

Obs.: Embalagem com 50un.

PL 9204

Derivador 2 vias para fio redondo 0,5mm² a 1,5mm²



CÓDIGO	EMB.
PL9204.00.00	01

Obs.: Embalagem com 50un.

PL 9205

Derivador Double Click para cabo ret. 2 x 0,75mm²



CÓDIGO	EMB.
PL9205.00.00	01

Obs.: Embalagem com 50un.

TRANSFORME SEU PONTO DE VENDA EM UMA VITRINE QUE VENDE POR VOCÊ.

Painel Full Supply

Exposição completa que valoriza sua linha e facilita a decisão de compra.

- Impresso em lona vinílica
- Aplicação de verniz protetor
- Moldura tipo pôster
- Haste para fixação
- Dimensões: 1,70 x 1,00m*

Pôster

Visual impactante para apresentar toda a linha e atrair a atenção do cliente.

- Impresso em papel couchê
- Aplicação de verniz protetor
- Dimensões: 66 x 99cm

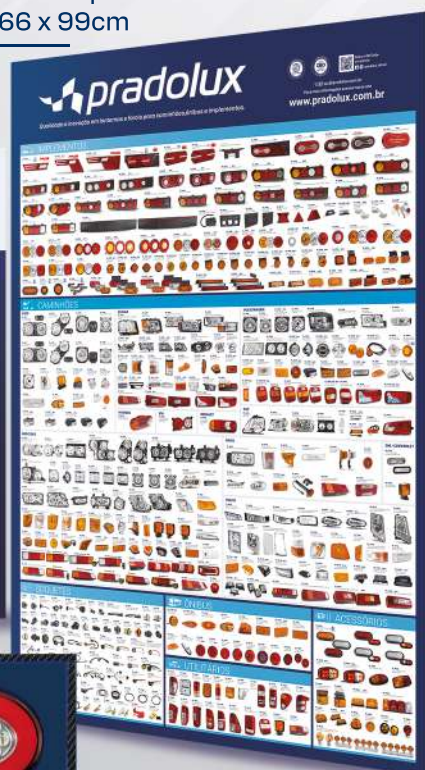

Triplo X

Modulus

Lanternas laterais

Balcão

Farol 7038

Painéis

Painéis em ACM com fonte bivolt

Consulte seu representante e implemente essa solução em sua loja.

*O painel pode ser adaptado de acordo com o espaço disponível na loja do cliente. Consulte com seu representante os modelos das lanternas aplicáveis neste painel.